

Advancing the art of making  
**SPRINGS**  
**BRAKE SHOE KITS**  
**OIL FILTERS**

 **SK SPRING**<sup>TM</sup>  
Technologies Private Limited



Designed to  
Perform  
Manufactured to  
Last



Established in the year 1978, we, an ISO/TS 16949:2009 & ISO 9001:2008 certified company, SK Spring Auto Components, are one of the leading and prominent manufacturers, suppliers and exporters of a broad assortment of the finest quality of Springs & Wire Forms.

Capable of producing more than 300 million Springs annually, with latest CNC controlled colling machines, grinding machines & special purpose machines, we are efficient in manufacturing any design of Springs as per the customer specifications.

Our product range is widely used in various automobile industries and engineering machines. In addition to this, the offered springs and wire forms are available with us in user-defined specifications. With our aid of our state-of-the-art infrastructure and a team of skilled professionals, we have been able to meet the precise needs of our esteemed patrons.

Mr. S.K. Gandhi, our founder and mentor, has helped us developing moral and ethical values, which has helped in building the company into one team. At SK Spring we believe in working closely with our customers to develop long-term relationships, which is mutually beneficial. To a large extent, our company's success is attributed to successful customer relations and exceeding expectations in terms of quality, performance, value and reliability.

At SK Spring, our engineering group has the technical expertise to provide customers with a wide range of supporting practices. We deliver the high service levels you would expect from a family-owned springs manufacturing business while maintaining the professionalism you want and need from a springs supplier.



## Raw Material Equivalent Standards

### Spring Steel - Medium Carbon Wire

<b>Indian Standard</b>	IS 4454 Part I, Grade-2
<b>Equivalent International Standards</b>	ASTM A 227 UNI 3823 Class B DIN 17223-1-1.0600 DIN 2076-B EN 10270-1(SM, DM) JIS-3522

### Spring Steel - High Carbon

<b>Indian Standard</b>	IS 4454 Part I Grade 3
<b>Equivalent International Standards</b>	ASTM A 228 UNI-3823 Class C DIN 17223-1-1.0200 DIN 2076-C EN 10270-1-(SH, DH) JIS-3522

### Spring Steel - Oil Tempered Alloy Steel Wire

<b>Indian Standard</b>	IS 4454 Part III, Grade-2D (Chrome Silicon)
<b>Equivalent International Standards</b>	ASTM A-401 DIN-17223-2 FDSiCr DIN-17223-2-VDSiCr EN-10270-2 FDSiCr EN 10270-2-VDSiCr

### Stainless Steel Wire

<b>Indian Standard</b>	IS 4454 part-IV Gr- 1 & 2
<b>Equivalent International Standards</b>	AISI 302 AISI 304 ASTM A 313 DIN 17224 EN 10270-3

## Manufacturing Facility

- CNC Wire Forming
- CNC Spring Coiling
- CNC Wire Bending
- Conveyorised Stress Relieving Furnaces
- Vertical Shot Peening
- CNC End Grinding Machines
- Pneumatic Scragging
- Conveyorised PT Line
- Conveyorised Powder Coating Facility
- German Made Mechanical Coiling Machines
- Circlips Forming Machine

## Design & Engineering

At SKS, our engineering group has the technical expertise to provide customers with a wide range of supporting practices. Contact us for design assistance. We offer a quick response to meet your needs from prototype springs to small batch springs to various high precision springs and high tech springs that require fast turnaround. We can run a thorough analysis to assist you in designing the best spring for your application.

- Custom engineering capability
- Computer aided design (CAD)
- Design modifications for cost efficient production
- Alternative manufacturing and materials evaluation
- Tooling designed & manufactured with minimal charges

## Quality Assurance

We believe quality should be a total team effort. This is a built in feature at Spring Manufacturing Corporation from design through the finished product, every step of the manufacturing process is carefully monitored. Specifications and tolerances are inspected utilizing advanced equipment.

At SKS, every spring is delivered with the finest quality that strictly adheres to the specifications rendered by the customers with timeliness.

### Our customers' success is our true success.

With an immense sense of commitment to attain perfection, SKS engages in an environment of integrity, authenticity, and mutual admiration.

## Testing Facility



## Our Esteemed Clients



**HITACHI Astemo**



**MAHLE**



**NAVISTAR**



## TIER 2 Suppliers to:



## BRAKE SHOE KITS Product Range



## BRAKE HARDWARE KIT QUICK REFERENCE

Brake Shoe Number	Brake Shoe Size	Hardware Kit Number	Brake Shoe Number	Brake Shoe Size	Hardware Kit Number
1307Q	15 X 3½	HK55	4514Q	16½ X 6	HK80XLS
1307Q	15 X 3½	HK77	4514Q	16½ X 6	HK81XLS
1307T	15 X 3½	HK50	4515E	16½ X 7	HK71
1307T	15 X 3½	HK51	4515F	16½ X 7	HK17XLS
1308A	15 X 4	HK53	4515FP	16½ X 7	HK17XLS
1308E	15 X 4	HK54	4515HA	16½ X 7	HK95XLS
1308Q	15 X 4	HK55	4515M	16½ X 7	HK75SD
1308Q	15 X 4	HK77	4515P	16½ X 7	HK14SD
1308T	15 X 4	HK50	4515P	16½ X 7	HK14XLS
1308T	15 X 4	HK51	4515P	16½ X 7	HK16
1443E	15 X 4	HK54	4515Q	16½ X 7	HK29
235-1245A	15 X 3	HK56	4515Q	16½ X 7	HK38
380-4596	15 X 6	HK60	4515X2	16½ X 7	HK31XLS
382-4597	15 X 7	HK60	4515X3	16½ X 7	HK34SD
4223E	16½ X 5	HK24SDLM	4515X3	16½ X 7	HK34XLS
4223E	16½ X 5	HK24XLSHM	4524HA	16½ X 5	HK95XLS
4223E	16½ X 5	HK24XLSLM	4524P	16½ X 5	HK14SD
4223E	16½ X 5	HK64XLS	4524P	16½ X 5	HK14XLS
4227G	14½ X 4	HK87	4524P	16½ X 5	HK16
4228B	14½ X 6	HK87	4524Q	16½ X 5	HK29
4284	18 X 7	HK27	4524Q	16½ X 5	HK38
4311E	16½ X 7	HK24SDLM	4524Q	16½ X 5	HK74XLS
4311E	16½ X 7	HK24XLSHM	4524Q	16½ X 5	HK80XLS
4311E	16½ X 7	HK24XLSLM	4524QM	16½ X 5	HK81XLS
4317E	16½ X 6	HK24SDLM	4527B	18 X 7	HK26
4317E	16½ X 6	HK24XLSHM	4536B	12¼ X 5½	HK43XLS
4317E	16½ X 6	HK24XLSLM	4536E	12¼ X 5½	HK47XLS-125
4317E	16½ X 6	HK64XLS	4536E	12¼ X 5½	HK47XLS-150
4350	20 X 8	HK46	4536FCII	12¼ X 5½	HK49-150
4398B	14½ X 5	HK86	4536P	12¼ X 5½	HK48XLS-125
4468	16½ X 7	HK22XLS	4536P	12¼ X 5½	HK48XLS-150
4471B	18 X 7	HK68	4541B	14½ X 8	HK85
4514HA	16½ X 6	HK95XLS	4544	12¼ X 5½	HK45XLS
4514P	16½ X 6	HK14SD	4544	12¼ X 5½	HK49-125
4514P	16½ X 6	HK14XLS	4544	12¼ X 5½	HK49-150
4514P	16½ X 6	HK16	4549P	16½ X 4	HK14SD
4514Q	16½ X 6	HK29	4549P	16½ X 4	HK14XLS
4514Q	16½ X 6	HK38	4549P	16½ X 4	HK16
4514Q	16½ X 6	HK74XLS	4549Q	16½ X 4	HK29

## BRAKE HARDWARE KIT QUICK REFERENCE

Brake Shoe Number	Brake Shoe Size	Hardware Kit Number	Brake Shoe Number	Brake Shoe Size	Hardware Kit Number
4549Q	16 <sup>1</sup> / <sub>2</sub> X 4	HK38	4707R	16 <sup>1</sup> / <sub>2</sub> X 7	HK38
4551P	16 <sup>1</sup> / <sub>2</sub> X 8 <sup>5</sup> / <sub>8</sub>	HK14SD	4708H	16 <sup>1</sup> / <sub>2</sub> X 7	HK72
4551P	16 <sup>1</sup> / <sub>2</sub> X 8 <sup>5</sup> / <sub>8</sub>	HK14XLS	4708M	16 <sup>1</sup> / <sub>2</sub> X 7	HK73
4551P	16 <sup>1</sup> / <sub>2</sub> X 8 <sup>5</sup> / <sub>8</sub>	HK16	4708P	16 <sup>1</sup> / <sub>2</sub> X 7	HK69XLS
4551Q	16 <sup>1</sup> / <sub>2</sub> X 8 <sup>5</sup> / <sub>8</sub>	HK29	4708Q	16 <sup>1</sup> / <sub>2</sub> X 7	HK67SD
4551Q	16 <sup>1</sup> / <sub>2</sub> X 8 <sup>5</sup> / <sub>8</sub>	HK38	4708Q	16 <sup>1</sup> / <sub>2</sub> X 7	HK67XLS
4552B	16 <sup>1</sup> / <sub>2</sub> X 10	HK22XLS	4708XEM	16 <sup>1</sup> / <sub>2</sub> X 7	HK65SD
4561	16 <sup>1</sup> / <sub>4</sub> X 3 <sup>1</sup> / <sub>2</sub>	HK52	4709	16 <sup>1</sup> / <sub>2</sub> X 7	HK63
4567P	16 <sup>1</sup> / <sub>2</sub> X 10	HK14SD	4709EII	16 <sup>1</sup> / <sub>2</sub> X 7	HK61
4567P	16 <sup>1</sup> / <sub>2</sub> X 10	HK14XLS	4710R	15 X 8 <sup>5</sup> / <sub>8</sub>	HK29XLS
4567P	16 <sup>1</sup> / <sub>2</sub> X 10	HK16	4711R	16 <sup>1</sup> / <sub>2</sub> X 8 <sup>5</sup> / <sub>8</sub>	HK29
4567Q	16 <sup>1</sup> / <sub>2</sub> X 10	HK29	4711R	16 <sup>1</sup> / <sub>2</sub> X 8 <sup>5</sup> / <sub>8</sub>	HK38
4567Q	16 <sup>1</sup> / <sub>2</sub> X 10	HK38	4715R	16 <sup>1</sup> / <sub>2</sub> X 6	HK29
4591	12 <sup>1</sup> / <sub>4</sub> X 7 <sup>1</sup> / <sub>2</sub>	HK40	4715R	16 <sup>1</sup> / <sub>2</sub> X 6	HK38
4591S	12 <sup>1</sup> / <sub>4</sub> X 7 <sup>1</sup> / <sub>2</sub>	HK43XLS	4715R	16 <sup>1</sup> / <sub>2</sub> X 6	HK74XLS
4592A	14 <sup>1</sup> / <sub>2</sub> X 10	HK83	4716EII	15 X 6	HK90XLS
4592A	14 <sup>1</sup> / <sub>2</sub> X 10	HK84	4717EII	15 X 8 <sup>5</sup> / <sub>8</sub>	HK91XLS
4607	12 <sup>1</sup> / <sub>4</sub> X 7 <sup>1</sup> / <sub>2</sub>	HK45XLS	4719	16 <sup>1</sup> / <sub>2</sub> X 5	HK63
4607	12 <sup>1</sup> / <sub>4</sub> X 7 <sup>1</sup> / <sub>2</sub>	HK49-125	4719EII	16 <sup>1</sup> / <sub>2</sub> X 5	HK61
4607	12 <sup>1</sup> / <sub>4</sub> X 7 <sup>1</sup> / <sub>2</sub>	HK49-150	4720R	16 <sup>1</sup> / <sub>2</sub> X 5	HK74XLS
4625B	16 <sup>1</sup> / <sub>2</sub> X 7	HK19SD	4720R	16 <sup>1</sup> / <sub>2</sub> X 5	HK38
4649	12 <sup>1</sup> / <sub>4</sub> X 8	HK41	4725	16 <sup>1</sup> / <sub>2</sub> X 5	HK63
4661C	12 <sup>1</sup> / <sub>4</sub> X 5	HK43XLS	4725EII	16 <sup>1</sup> / <sub>2</sub> X 6	HK61
4661FCII	12 <sup>1</sup> / <sub>4</sub> X 5	HK49-150	4726EII	16 <sup>1</sup> / <sub>2</sub> X 8 <sup>5</sup> / <sub>8</sub>	HK61
4669D	18 X 7	HK76			
4670Q	12 <sup>1</sup> / <sub>4</sub> X 7 <sup>1</sup> / <sub>2</sub>	HK44XLS			
4692	12 <sup>1</sup> / <sub>4</sub> X 7 <sup>1</sup> / <sub>2</sub>	HK47XLS-125			
4692	12 <sup>1</sup> / <sub>4</sub> X 7 <sup>1</sup> / <sub>2</sub>	HK47XLS-150			
4692FC	12 <sup>1</sup> / <sub>4</sub> X 7 <sup>1</sup> / <sub>2</sub>	HK58XLS			
4692FCII	12 <sup>1</sup> / <sub>4</sub> X 7 <sup>1</sup> / <sub>2</sub>	HK49-150			
4692P	12 <sup>1</sup> / <sub>4</sub> X 7 <sup>1</sup> / <sub>2</sub>	HK48XLS-125			
4692P	12 <sup>1</sup> / <sub>4</sub> X 7 <sup>1</sup> / <sub>2</sub>	HK48XLS-150			
4693	15 X 4	HK70			
4693HA	15 X 4	HK95XLS			
4700	12 <sup>1</sup> / <sub>4</sub> X 4	HK43XLS			
4701HA	16 <sup>1</sup> / <sub>2</sub> X 7	HK96XLS			
4701Q	16 <sup>1</sup> / <sub>2</sub> X 7	HK32SD			
4702R	15 X 4	HK29XLS			
4707R	16 <sup>1</sup> / <sub>2</sub> X 7	HK29			

## Hardware Kit General Features



	SKS Kits
<b>Application</b>	Standard Service Platforms
<b>Market</b>	Trailer, Line Haul
<b>Return Spring</b>	Standard Heat Treated Music Wire
<b>Cam Roller</b>	Smooth
<b>Anchor Pin Bushing</b>	Steel or Composite
<b>Lubricant</b>	Not Applicable

Genuine SK Spring Hardware Kits are designed for every application and operating condition. Choose from three levels of hardware kits designed to meet the specific needs of your fleets:

- SK Spring Hardware Kits meet or exceed all OE standards and are specifically designed for trailer and line haul applications.
- SK Spring XLS Hardware Kits, designed to meet the demands of the SK Spring Extended Service brake systems, feature knurled rollers, heavy-duty return springs and stainless steel anchor pin bushings.
- SK Spring SD Hardware Kits, designed for the most severe applications, feature anti-seize lubricant and dimpled stainless steel bushings. The combination of these components reduce anchor pin to bushing seizure, making future brake changes easier.

**For superior performance and the "Lowest Cost per Mile" choose SK Spring.**

Disclaimer: All OE Names and Part number are for reference only and we claim no right on them



## BRAKE HARDWARE KITS



### Kit Number: SKSTHK14SD

SKST No.	Description	Qty.
15-527	Anchor Pin	2
16-700	Anchor Pin Bushing - Dimpled Stainless Steel	2
19-853	Return Spring - Heavy Duty	1
20-881	Return Spring Pin	2
32-1428	Cam Roller - Knurled	2
34-1525	Camshaft Lockring	4
34-1532	Cam Roller Retainer - Rockwell	2
35-1580	Anchor Pin Washer	4
Antiseize	Hw Kit Lubricant	1

#### Application

4514P	16 $\frac{1}{2}$ X 6	ROCKWELL P
4515P	16 $\frac{1}{2}$ X 7	ROCKWELL / MERITOR P
4515P	16 $\frac{1}{2}$ X 7	FT
4524P	16 $\frac{1}{2}$ X 5	ROCKWELL P
4549P	16 $\frac{1}{2}$ X 4	ROCKWELL P
4551P	16 $\frac{1}{2}$ X 8 $\frac{5}{8}$	ROCKWELL P
4567P	16 $\frac{1}{2}$ X 10	ROCKWELL / MERITOR P

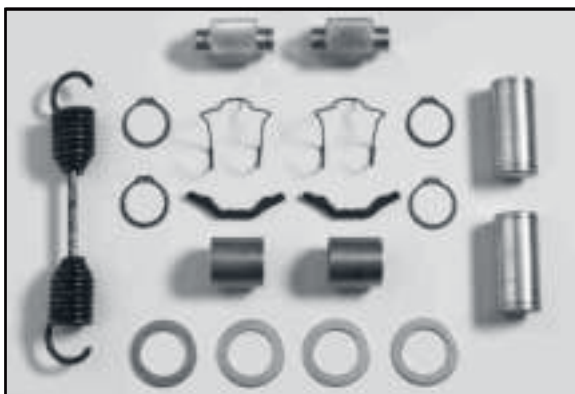

### Kit Number: SKSTHK14XLS

SKST No.	Description	Qty.
15-527	Anchor Pin	2
16-563	Anchor Pin Bushing - Stainless Steel	2
19-853	Return Spring - Heavy Duty	1
20-881	Return Spring Pin	2
32-1428	Cam Roller - Knurled	2
34-1525	Camshaft Lockring	4
34-1532	Cam Roller Retainer - Rockwell	2
35-1580	Anchor Pin Washer	4

#### Application

4514P	16 $\frac{1}{2}$ X 6	ROCKWELL P
4515P	16 $\frac{1}{2}$ X 7	ROCKWELL / MERITOR P
4515P	16 $\frac{1}{2}$ X 7	FT
4524P	16 $\frac{1}{2}$ X 5	ROCKWELL P
4549P	16 $\frac{1}{2}$ X 4	ROCKWELL P
4551P	16 $\frac{1}{2}$ X 8 $\frac{5}{8}$	ROCKWELL P
4567P	16 $\frac{1}{2}$ X 10	ROCKWELL / MERITOR P

## BRAKE HARDWARE KITS



### Kit Number: SKSTHK16

SKST No.	Description	Qty.
15-526	Anchor Pin	2
19-856	Return Spring	1
20-881	Return Spring Pin	2
32-1425	Cam Roller - Smooth	2
34-1525	Camshaft Lockring	4
34-1529	Cam Roller Retainer	2
34-1539	Anchor Pin Lock Screw	2
35-1582	Neoprene Anchor Pin Seal	4

#### Application

4514P	16 $\frac{1}{2}$ X 6	ROCKWELL P
4515P	16 $\frac{1}{2}$ X 7	ROCKWELL / MERITOR P
4515P	16 $\frac{1}{2}$ X 7	FT
4524P	16 $\frac{1}{2}$ X 5	ROCKWELL P
4549P	16 $\frac{1}{2}$ X 4	ROCKWELL P
4551P	16 $\frac{1}{2}$ X 8 $\frac{5}{8}$	ROCKWELL P
4567P	16 $\frac{1}{2}$ X 10	ROCKWELL / MERITOR P



### Kit Number: SKSTHK16SD

SKST No.	Description	Qty.
15-526	Anchor Pin	2
19-853	Return Spring - Heavy Duty	1
20-881	Return Spring Pin	2
32-1428	Cam Roller - Knurled	2
34-1525	Camshaft Lockring	4
34-1532	Cam Roller Retainer - Rockwell	2
34-1539	Anchor Pin Lock Screw	2
35-1582	Neoprene Anchor Pin Seal	4
Antiseize	Hw Kit Lubricant	1

#### Application

4514P	16 $\frac{1}{2}$ X 6	ROCKWELL P
4515P	16 $\frac{1}{2}$ X 7	ROCKWELL / MERITOR P
4515P	16 $\frac{1}{2}$ X 7	FT
4524P	16 $\frac{1}{2}$ X 5	ROCKWELL P
4549P	16 $\frac{1}{2}$ X 4	ROCKWELL P
4551P	16 $\frac{1}{2}$ X 8 $\frac{5}{8}$	ROCKWELL P
4567P	16 $\frac{1}{2}$ X 10	ROCKWELL / MERITOR P

## BRAKE HARDWARE KITS



### Kit Number: SKSTHK16XLS

SKST No.	Description	Qty.
15-526	Anchor Pin	2
19-853	Return Spring - Heavy Duty	1
20-881	Return Spring Pin	2
32-1428	Cam Roller - Knurled	2
34-1525	Camshaft Lockring	4
34-1532	Cam Roller Retainer - Rockwell	2
34-1539	Anchor Pin Lock Screw	2
35-1582	Neoprene Anchor Pin Seal	4

#### Application

4514P	16 $\frac{1}{2}$ X 6	ROCKWELL P
4515P	16 $\frac{1}{2}$ X 7	ROCKWELL / MERITOR P
4515P	16 $\frac{1}{2}$ X 7	FT
4524P	16 $\frac{1}{2}$ X 5	ROCKWELL P
4549P	16 $\frac{1}{2}$ X 4	ROCKWELL P
4551P	16 $\frac{1}{2}$ X 8 $\frac{5}{8}$	ROCKWELL P
4567P	16 $\frac{1}{2}$ X 10	ROCKWELL / MERITOR P

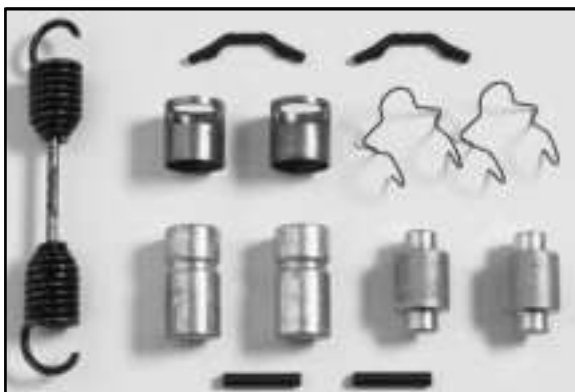

### Kit Number: SKSTHK17XLS

SKST No.	Description	Qty.
15-529	Anchor Pin	2
16-561	Anchor Pin Bushing - Os Slot	2
19-853	Return Spring - Heavy Duty	1
20-881	Return Spring Pin	2
32-1428	Cam Roller - Knurled	2
34-1532	Cam Roller Retainer - Rockwell	2
34-1533	Roll Pin Lock	2

#### Application

4515F	16 $\frac{1}{2}$ X 7	FRUEHAUF P 1st
4515FP	16 $\frac{1}{2}$ X 7	FRUEHAUF P

## BRAKE HARDWARE KITS



### Kit Number: SKSTHK19SD

SKST No.	Description	Qty.
15-532	Anchor Pin	2
19-853	Return Spring - Heavy Duty	1
20-881	Return Spring Pin	2
23-1026	Brake Shoe Bushing	4
32-1431	Cam Roller - Smooth	2
34-1525	Camshaft Lockring	4
34-1539	Anchor Pin Lock Screw	2
35-1582	Neoprene Anchor Pin Seal	4
Antiseize	Hw Kit Lubricant	1

#### Application

4625B 16½ X 7 MACK P



### Kit Number: SKSTHK22XLS

SKST No.	Description	Qty.
15-532	Anchor Pin	2
19-853	Return Spring - Heavy Duty	1
23-1026	Brake Shoe Bushing	4
32-1435	Cam Roller - Smooth	2
32-1440	Cam Roller Pin	2
34-1525	Camshaft Lockring	4
34-1539	Anchor Pin Lock Screw	2
34-1540	Roller Pin Set Screw	2
35-1577	Retainer	4
35-1582	Neoprene Anchor Pin Seal	4

#### Application

4468 16½ X 7 STD FORGE CAST SHOE  
4552B 16½ X 10 CAST SHOE



### Kit Number: SKSTHK24SDLM

SKST No.	Description	Qty.
19-854	Return Spring	1
19-859	Retainer Spring	2
32-1441A	Cam Roller - Knurled	2
32-1442A	Cam Roller Pin	2
Antiseize	Hw Kit Lubricant	1

#### Application

4223E 16½ X 5 SAP  
4311E 16½ X 7 SAP  
4317E 16½ X 6 SAP

## BRAKE HARDWARE KITS



### Kit Number: SKSTHK24XLSHM

SKST No.	Description	Qty.
19-859	Retainer Spring	2
19-874	Return Spring	1
32-1441A	Cam Roller - Knurled	2
32-1442A	Cam Roller Pin	2

#### Application

4223E	16 <sup>1</sup> / <sub>2</sub> X 5
4311E	16 <sup>1</sup> / <sub>2</sub> X 7
4317E	16 <sup>1</sup> / <sub>2</sub> X 6



### Kit Number: SKSTHK24XLSLM

SKST No.	Description	Qty.
19-854	Return Spring	1
19-859	Retainer Spring	2
32-1441A	Cam Roller - Knurled	2
32-1442A	Cam Roller Pin	2

#### Application

4223E	16 <sup>1</sup> / <sub>2</sub> X 5
4311E	16 <sup>1</sup> / <sub>2</sub> X 7
4317E	16 <sup>1</sup> / <sub>2</sub> X 6

- High mount shoes and low mount shoes use different return springs.
- High mount shoes can replace low mount shoes in all applications with the appropriate hardware kits.
- Low mount shoes cannot replace high mount shoes .

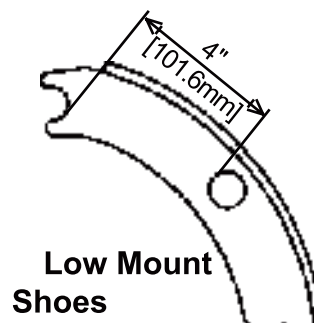
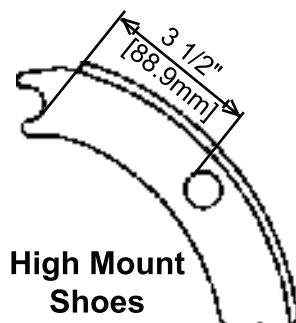

## BRAKE HARDWARE KITS



### Kit Number: SKSTHK26

SKST No.	Description	Qty.
19-876	Return Spring	1
19-877	Retainer Spring	2
32-1443	Wide Web Cam Roller	2
32-1444	Cam Roller Pin	2

#### Application

4527B

18 X 7

CAST SHOE



### Kit Number: SKSTHK27

SKST No.	Description	Qty.
15-526	Anchor Pin	2
19-853	Return Spring - Heavy Duty	1
20-881	Return Spring Pin	2
32-1445	Cam Roller - Knurled	2
32-1446	Cam Roller Pin	2
34-1525	Camshaft Lockring	4
34-1526	Lockring	2
35-1582	Neoprene Anchor Pin Seal	4

#### Application

4284

18 X 7

STD FORGE FABRICATED

## BRAKE HARDWARE KITS

### Kit Number: SKSTHK29



SKST No.	Description	Qty.
15-542	Anchor Pin	2
16-565	Anchor Pin Bushing	2
19-856A	Return Spring	1
19-860	Return Spring	2
20-881	Return Spring Pin	2
32-1425	Cam Roller - Smooth	2
34-1529	Cam Roller Retainer	2

#### Application

4514Q	16 <sup>1</sup> / <sub>2</sub> X 6	ROCKWELL / MERITOR Q
4515Q	16 <sup>1</sup> / <sub>2</sub> X 7	ROCKWELL / MERITOR Q
4515Q	16 <sup>1</sup> / <sub>2</sub> X 7	FC
4524Q	16 <sup>1</sup> / <sub>2</sub> X 5	ROCKWELL / MERITOR Q
4524Q	16 <sup>1</sup> / <sub>2</sub> X 5	FC
4549Q	16 <sup>1</sup> / <sub>2</sub> X 4	ROCKWELL Q
4551Q	16 <sup>1</sup> / <sub>2</sub> X 8 <sup>5</sup> / <sub>8</sub>	ROCKWELL / MERITOR Q
4551Q	16 <sup>1</sup> / <sub>2</sub> X 8 <sup>5</sup> / <sub>8</sub>	FC
4567Q	16 <sup>1</sup> / <sub>2</sub> X 10	ROCKWELL / MERITOR Q
4702R	15 X 4	ROCKWELL / MERITOR Q PLUS
4702R	15 X 4	XTRALIFE II
4707R	16 <sup>1</sup> / <sub>2</sub> X 7	ROCKWELL / MERITOR Q PLUS
4707R	16 <sup>1</sup> / <sub>2</sub> X 7	XTRALIFE II
4710R	15 X 8 <sup>5</sup> / <sub>8</sub>	ROCKWELL / MERITOR Q PLUS
4710R	15 X 8 <sup>5</sup> / <sub>8</sub>	XTRALIFE II
4711R	16 <sup>1</sup> / <sub>2</sub> X 8 <sup>5</sup> / <sub>8</sub>	ROCKWELL / MERITOR Q PLUS
4715R	16 <sup>1</sup> / <sub>2</sub> X 6	ROCKWELL / MERITOR Q PLUS
4720R	16 <sup>1</sup> / <sub>2</sub> X 5	ROCKWELL / MERITOR Q PLUS
4720R	16 <sup>1</sup> / <sub>2</sub> X 5	XTRALIFE II

## BRAKE HARDWARE KITS

**Kit Number: SKSTHK29SD**

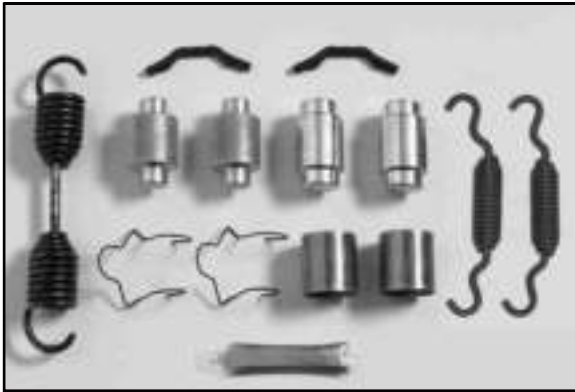

SKST No.	Description	Qty.
15-542	Anchor Pin	2
16-700	Anchor Pin Bushing - Dimpled Stainless Steel	2
19-853A	Return Spring - Heavy Duty	1
19-860	Return Spring	2
20-881	Return Spring Pin	2
32-1428	Cam Roller - Knurled	2
34-1532	Cam Roller Retainer - Rockwell	2
Antiseize	Hw Kit Lubricant	1

### Application

4514Q	16 <sup>1</sup> / <sub>2</sub> X 6	ROCKWELL / MERITOR Q
4515Q	16 <sup>1</sup> / <sub>2</sub> X 7	ROCKWELL / MERITOR Q
4515Q	16 <sup>1</sup> / <sub>2</sub> X 7	FC
4524Q	16 <sup>1</sup> / <sub>2</sub> X 5	ROCKWELL / MERITOR Q
4524Q	16 <sup>1</sup> / <sub>2</sub> X 5	FC
4549Q	16 <sup>1</sup> / <sub>2</sub> X 4	ROCKWELL Q
4551Q	16 <sup>1</sup> / <sub>2</sub> X 8 <sup>5</sup> / <sub>8</sub>	ROCKWELL / MERITOR Q
4551Q	16 <sup>1</sup> / <sub>2</sub> X 8 <sup>5</sup> / <sub>8</sub>	FC
4567Q	16 <sup>1</sup> / <sub>2</sub> X 10	ROCKWELL / MERITOR Q
4702R	15 X 4	ROCKWELL / MERITOR Q PLUS
4702R	15 X 4	XTRALIFE II
4707R	16 <sup>1</sup> / <sub>2</sub> X 7	ROCKWELL / MERITOR Q PLUS
4707R	16 <sup>1</sup> / <sub>2</sub> X 7	XTRALIFE II
4710R	15 X 8 <sup>5</sup> / <sub>8</sub>	ROCKWELL / MERITOR Q PLUS
4710R	15 X 8 <sup>5</sup> / <sub>8</sub>	XTRALIFE II
4711R	16 <sup>1</sup> / <sub>2</sub> X 8 <sup>5</sup> / <sub>8</sub>	ROCKWELL / MERITOR Q PLUS
4715R	16 <sup>1</sup> / <sub>2</sub> X 6	ROCKWELL / MERITOR Q PLUS
4720R	16 <sup>1</sup> / <sub>2</sub> X 5	ROCKWELL / MERITOR Q PLUS
4720R	16 <sup>1</sup> / <sub>2</sub> X 5	XTRALIFE II



## BRAKE HARDWARE KITS

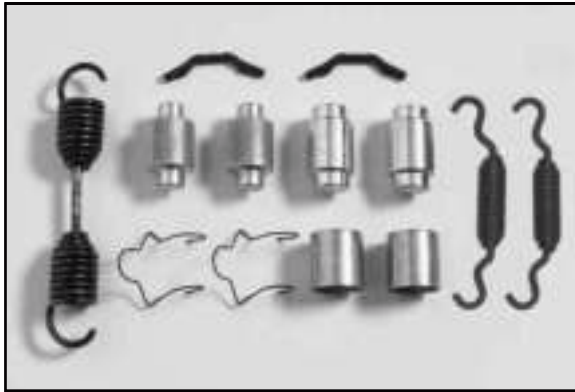

### Kit Number: SKSTHK29XLS

SKST No.	Description	Qty.
15-542	Anchor Pin	2
16-563	Anchor Pin Bushing - Stainless Steel	2
19-853A	Return Spring - Heavy Duty	1
19-860	Return Spring	2
20-881	Return Spring Pin	2
32-1428	Cam Roller - Knurled	2
34-1532	Cam Roller Retainer - Rockwell	2

#### Application

4514Q	16 <sup>1</sup> / <sub>2</sub> X 6	ROCKWELL / MERITOR Q
4515Q	16 <sup>1</sup> / <sub>2</sub> X 7	ROCKWELL / MERITOR Q
4515Q	16 <sup>1</sup> / <sub>2</sub> X 7	FC
4524Q	16 <sup>1</sup> / <sub>2</sub> X 5	ROCKWELL / MERITOR Q
4524Q	16 <sup>1</sup> / <sub>2</sub> X 5	FC
4549Q	16 <sup>1</sup> / <sub>2</sub> X 4	ROCKWELL Q
4551Q	16 <sup>1</sup> / <sub>2</sub> X 8 <sup>5</sup> / <sub>8</sub>	ROCKWELL / MERITOR Q
4551Q	16 <sup>1</sup> / <sub>2</sub> X 8 <sup>5</sup> / <sub>8</sub>	FC
4567Q	16 <sup>1</sup> / <sub>2</sub> X 10	ROCKWELL / MERITOR Q
4702R	15 X 4	ROCKWELL / MERITOR Q PLUS
4702R	15 X 4	XTRALIFE II
4707R	16 <sup>1</sup> / <sub>2</sub> X 7	ROCKWELL / MERITOR Q PLUS
4707R	16 <sup>1</sup> / <sub>2</sub> X 7	XTRALIFE II
4710R	15 X 8 <sup>5</sup> / <sub>8</sub>	ROCKWELL / MERITOR Q PLUS
4710R	15 X 8 <sup>5</sup> / <sub>8</sub>	XTRALIFE II
4711R	16 <sup>1</sup> / <sub>2</sub> X 8 <sup>5</sup> / <sub>8</sub>	ROCKWELL / MERITOR Q PLUS
4715R	16 <sup>1</sup> / <sub>2</sub> X 6	ROCKWELL / MERITOR Q PLUS
4720R	16 <sup>1</sup> / <sub>2</sub> X 5	ROCKWELL / MERITOR Q PLUS
4720R	16 <sup>1</sup> / <sub>2</sub> X 5	XTRALIFE II

## BRAKE HARDWARE KITS

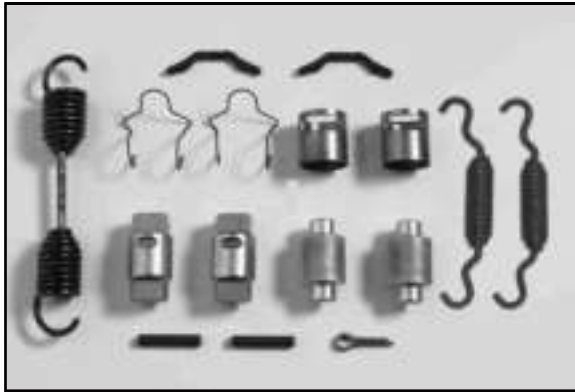

### Kit Number: SKSTHK31XLS

SKST No.	Description	Qty.
12-403	Cotter Pin	1
15-543	Anchor Pin	2
16-561	Anchor Pin Bushing - Os Slot	2
19-853A	Return Spring - Heavy Duty	1
19-860	Return Spring	2
20-881	Return Spring Pin	2
32-1428	Cam Roller - Knurled	2
34-1532	Cam Roller Retainer - Rockwell	2
34-1533	Roll Pin Lock	2

#### Application

4515X2 16½ X 7 FRUEHAUF XEM 2nd

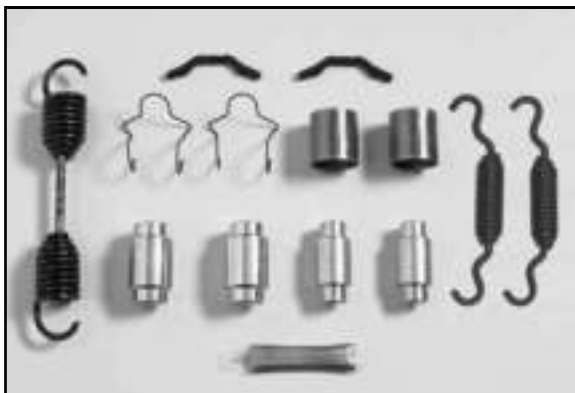

### Kit Number: SKSTHK32SD

SKST No.	Description	Qty.
15-542	Anchor Pin	2
16-700	Anchor Pin Bushing - Dimpled Stainless Steel	2
19-853	Return Spring - Heavy Duty	1
19-860	Return Spring	2
20-881	Return Spring Pin	2
32-1430	Cam Roller - Smooth	2
34-1532	Cam Roller Retainer - Rockwell	2
Antiseize	Hw Kit Lubricant	1

#### Application

4701Q 16½ X 7 Q



### Kit Number: SKSTHK34SD

SKST No.	Description	Qty.
12-403	Cotter Pin	1
15-536	Anchor Pin	2
16-700	Anchor Pin Bushing - Dimpled Stainless Steel	2
19-853A	Return Spring - Heavy Duty	1
19-860	Return Spring	2
20-881	Return Spring Pin	2
32-1428	Cam Roller - Knurled	2
34-1530	Cam Roller Retainer	2
Antiseize	Hw Kit Lubricant	1

#### Application

4515X3 16½ X 7 FRUEHAUF XEM 3RD

## BRAKE HARDWARE KITS



### Kit Number: SKSTHK34XLS

SKST No.	Description	Qty.
12-403	Cotter Pin	1
15-536	Anchor Pin	2
16-563	Anchor Pin Bushing - Stainless Steel	2
19-853A	Return Spring - Heavy Duty	1
19-860	Return Spring	2
20-881	Return Spring Pin	2
32-1428	Cam Roller - Knurled	2
34-1532	Cam Roller Retainer - Rockwell	2

#### Application

4515X3    16 $\frac{1}{2}$  X 7    FRUEHAUF XEM 3RD

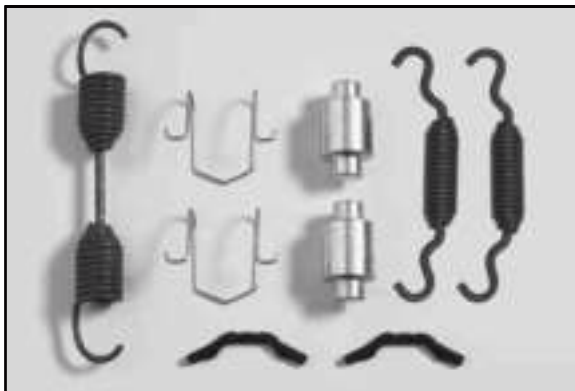

### Kit Number: SKSTHK38

SKST No.	Description	Qty.
19-856A	Return Spring	1
19-860	Return Spring	2
20-881	Return Spring Pin	2
32-1425	Cam Roller - Smooth	2
34-1529	Cam Roller Retainer	2

#### Application

4514Q	16 $\frac{1}{2}$ X 6	ROCKWELL / MERITOR Q
4515Q	16 $\frac{1}{2}$ X 7	ROCKWELL / MERITOR Q
4515Q	16 $\frac{1}{2}$ X 7	FC
4524Q	16 $\frac{1}{2}$ X 5	ROCKWELL / MERITOR Q
4524Q	16 $\frac{1}{2}$ X 5	FC
4549Q	16 $\frac{1}{2}$ X 4	ROCKWELL Q
4551Q	16 $\frac{1}{2}$ X 8 $\frac{5}{8}$	ROCKWELL / MERITOR Q
4551Q	16 $\frac{1}{2}$ X 8 $\frac{5}{8}$	FC
4567Q	16 $\frac{1}{2}$ X 10	ROCKWELL / MERITOR Q
4707R	16 $\frac{1}{2}$ X 7	ROCKWELL / MERITOR Q PLUS
4707R	16 $\frac{1}{2}$ X 7	XTRALIFE II
4711R	16 $\frac{1}{2}$ X 8 $\frac{5}{8}$	ROCKWELL / MERITOR Q PLUS
4715R	16 $\frac{1}{2}$ X 6	ROCKWELL / MERITOR Q PLUS
4720R	16 $\frac{1}{2}$ X 5	ROCKWELL / MERITOR Q PLUS
4720R	16 $\frac{1}{2}$ X 5	XTRALIFE II

## BRAKE HARDWARE KITS



### Kit Number: SKSTHK38XLS

SKST No.	Description	Qty.
19-853A	Return Spring - Heavy Duty	1
19-860	Return Spring	2
20-881	Return Spring Pin	2
32-1428	Cam Roller - Knurled	2
34-1532	Cam Roller Retainer - Rockwell	2

#### Application

4514Q	16 <sup>1</sup> / <sub>2</sub> X 6	ROCKWELL / MERITOR Q
4515Q	16 <sup>1</sup> / <sub>2</sub> X 7	ROCKWELL / MERITOR Q
4515Q	16 <sup>1</sup> / <sub>2</sub> X 7	FC
4524Q	16 <sup>1</sup> / <sub>2</sub> X 5	ROCKWELL / MERITOR Q
4524Q	16 <sup>1</sup> / <sub>2</sub> X 5	FC
4549Q	16 <sup>1</sup> / <sub>2</sub> X 4	ROCKWELL Q
4551Q	16 <sup>1</sup> / <sub>2</sub> X 8 <sup>5</sup> / <sub>8</sub>	ROCKWELL / MERITOR Q
4551Q	16 <sup>1</sup> / <sub>2</sub> X 8 <sup>5</sup> / <sub>8</sub>	FC
4567Q	16 <sup>1</sup> / <sub>2</sub> X 10	ROCKWELL / MERITOR Q
4707R	16 <sup>1</sup> / <sub>2</sub> X 7	ROCKWELL / MERITOR Q PLUS
4707R	16 <sup>1</sup> / <sub>2</sub> X 7	XTRALIFE II
4711R	16 <sup>1</sup> / <sub>2</sub> X 8 <sup>5</sup> / <sub>8</sub>	ROCKWELL / MERITOR Q PLUS
4715R	16 <sup>1</sup> / <sub>2</sub> X 6	ROCKWELL / MERITOR Q PLUS
4720R	16 <sup>1</sup> / <sub>2</sub> X 5	ROCKWELL / MERITOR Q PLUS
4720R	16 <sup>1</sup> / <sub>2</sub> X 5	XTRALIFE II



### Kit Number: SKSTHK40

	Description	Qty.
15-540	Anchor Pin	1
19-864	Return Spring	1
19-866	Retainer Spring	2
29-1301	Camshaft Lockring	1
29-1307	Camshaft Washer	2
32-1429	Cam Roller - Smooth	2
34-1545	Anchor Pin Lock Nut	1
34-1546	Anchor Pin Lockwasher	1

#### Application

4591	12 <sup>1</sup> / <sub>4</sub> X 7 <sup>1</sup> / <sub>2</sub>	EATON SHULER
------	--	--------------

## BRAKE HARDWARE KITS



### Kit Number: SKSTHK41

	Description	Qty.
15-529	Anchor Pin	2
16-561	Anchor Pin Bushing - Os Slot	2
19-863	Return Spring	1
20-881	Return Spring Pin	2
32-1430	Cam Roller - Smooth	2
34-1531	Cam Roller Retainer	2
34-1533	Roll Pin Lock	2

#### Application

4649      12<sup>1</sup>/<sub>4</sub> X 8      FRUEHAUF DAP



### Kit Number: SKSTHK43XLS

	Description	Qty.
15-537	Anchor Pin	2
16-564	Anchor Pin Bushing - Stainless Steel	2
19-862	Return Spring - Heavy Duty	1
20-882	Return Spring Pin	2
32-1445	Cam Roller - Knurled	2
32-1446	Cam Roller Pin	2
34-1526	Lockring	2
34-1527	Camshaft Lockring	4
35-1581	Anchor Pin Washer	4

#### Application

4536B      12<sup>1</sup>/<sub>4</sub> X 5<sup>1</sup>/<sub>2</sub>      STD FORGE  
 4591S      12<sup>1</sup>/<sub>4</sub> X 7<sup>1</sup>/<sub>2</sub>      STD. FORGE & AXLE  
 4661C      12<sup>1</sup>/<sub>4</sub> X 5      DEXTER  
 4700      12<sup>1</sup>/<sub>4</sub> X 4      DEXTER



### Kit Number: SKSTHK44XLS

SKST No.	Description	Qty.
15-542	Anchor Pin	2
16-563	Anchor Pin Bushing - Stainless Steel	2
19-860	Return Spring	2
19-882	Return Spring - Heavy Duty	1
20-881	Return Spring Pin	2
32-1467	Cam Roller - Knurled	2
32-1468	Cam Roller Pin	2
34-1526	Lockring	4

#### Application

4670Q      12<sup>1</sup>/<sub>4</sub> X 7<sup>1</sup>/<sub>2</sub>      ROCKWELL / MERITOR TRAILER AXL

## BRAKE HARDWARE KITS



### Kit Number: SKSTHK45XLS

SKST No.	Description	Qty.
15-539	Anchor Pin	2
19-862	Return Spring - Heavy Duty	1
20-882	Return Spring Pin	2
32-1445	Cam Roller - Knurled	2
32-1446	Cam Roller Pin	2
34-1526	Lockring	2
34-1527	Camshaft Lockring	2
34-1536	3/4 -16 Anchor Pin Nut	2
34-1544	Anchor Pin Link	2
35-1581	Anchor Pin Washer	2

#### Application

4544	12 <sup>1</sup> / <sub>4</sub> X 5 <sup>1</sup> / <sub>2</sub>	STD FORGE
4607	12 <sup>1</sup> / <sub>4</sub> X 7 <sup>1</sup> / <sub>2</sub>	STD FORGE



### Kit Number: SKSTHK46

SKST No.	Description	Qty.
15-544	Anchor Pin	2
19-880	Return Spring	1
23-1032	Brake Shoe Bushing	4
29-1269	Spider Seal	4
29-1301	Camshaft Lockring	4
32-1453	Cam Roller Pin	2
32-1454	Cam Roller	2
34-1527	Camshaft Lockring	4
34-1539	Anchor Pin Lock Screw	2

#### Application

4350	20 X 8	CAST SHOE
------	--------	-----------

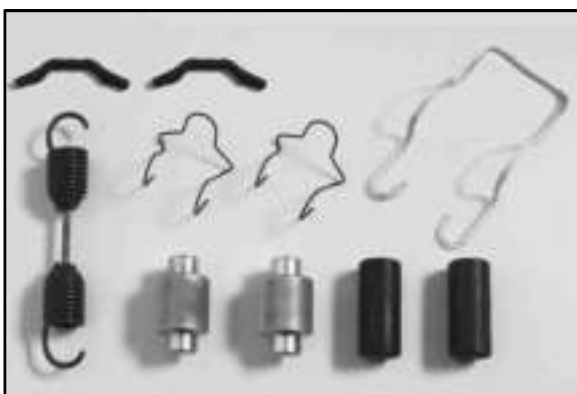

### Kit Number: SKSTHK47XLS-125

SKST No.	Description	Qty.
15-545	Anchor Pin	2
19-862	Return Spring - Heavy Duty	1
20-881	Return Spring Pin	2
32-1428	Cam Roller - Knurled	2
34-1532	Cam Roller Retainer - Rockwell	2
34-1563	Anchor Pin Retainer	1

#### Application

4536E	12 <sup>1</sup> / <sub>4</sub> X 5 <sup>1</sup> / <sub>2</sub>	U BRAKE
4692	12 <sup>1</sup> / <sub>4</sub> X 7 <sup>1</sup> / <sub>2</sub>	U BRAKE

## BRAKE HARDWARE KITS

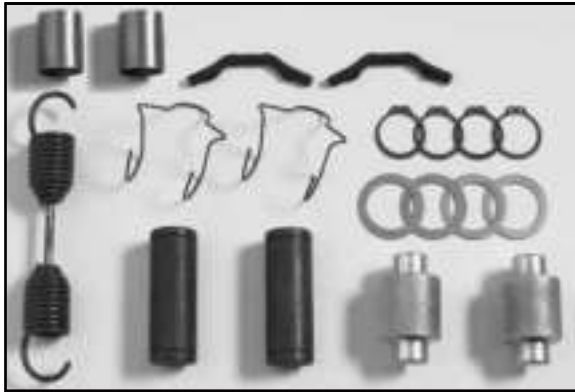

### Kit Number: SKSTHK48XLS-125

SKST No.	Description	Qty.
15-537	Anchor Pin	2
16-564	Anchor Pin Bushing - Stainless Steel	2
19-862	Return Spring - Heavy Duty	1
20-881	Return Spring Pin	2
32-1428	Cam Roller - Knurled	2
34-1527	Camshaft Lockring	4
34-1532	Cam Roller Retainer - Rockwell	2
35-1581	Anchor Pin Washer	4

#### Application

4536P 12<sup>1</sup>/<sub>4</sub> X 5<sup>1</sup>/<sub>2</sub>  
4692P 12<sup>1</sup>/<sub>4</sub> X 7<sup>1</sup>/<sub>2</sub>

FT TIMKEN FABRICATED  
FT TIMKEN FABRICATED



### Kit Number: SKSTHK48XLS-150

SKST No.	Description	Qty.
15-537	Anchor Pin	2
16-564	Anchor Pin Bushing - Stainless Steel	2
19-862	Return Spring - Heavy Duty	1
20-881	Return Spring Pin	2
32-1427	Cam Roller - Smooth	2
34-1527	Camshaft Lockring	4
34-1532	Cam Roller Retainer - Rockwell	2
35-1581	Anchor Pin Washer	4

#### Application

4536P 12<sup>1</sup>/<sub>4</sub> X 5<sup>1</sup>/<sub>2</sub>  
4692P 12<sup>1</sup>/<sub>4</sub> X 7<sup>1</sup>/<sub>2</sub>

FT TIMKEN FABRICATED  
FT TIMKEN FABRICATED



### Kit Number: SKSTHK49-125

SKST No.	Description	Qty.
15-539	Anchor Pin	2
19-862	Return Spring - Heavy Duty	1
20-882	Return Spring Pin	2
32-1425	Cam Roller - Smooth	2
34-1526	Lockring	2
34-1529	Cam Roller Retainer	2
34-1536	3/4 -16 Anchor Pin Nut	2
34-1537	Anchor Pin Lockwasher	2
34-1544	Anchor Pin Link	2
35-1581	Anchor Pin Washer	2

#### Application

4544 12<sup>1</sup>/<sub>4</sub> X 5<sup>1</sup>/<sub>2</sub>  
4607 12<sup>1</sup>/<sub>4</sub> X 7<sup>1</sup>/<sub>2</sub>

STD FORGE  
STD FORGE

## BRAKE HARDWARE KITS



### Kit Number: SKSTHK49-150

SKST No.	Description	Qty.
15-537	Anchor Pin	2
15-542	Anchor Pin	2
16-565	Anchor Pin Bushing	2
19-862	Return Spring - Heavy Duty	1
19-941	Retainer Spring - 12 <sup>1</sup> / <sub>4</sub> 2	
20-881	Return Spring Pin	2
32-1427	Cam Roller - Smooth	2
34-1527	Camshaft Lockring	4
34-1529	Cam Roller Retainer	2
35-1581	Anchor Pin Washer	4

#### Application

4536FCII	12 <sup>1</sup> / <sub>4</sub> X 5 <sup>1</sup> / <sub>2</sub>	FCII
4544	12 <sup>1</sup> / <sub>4</sub> X 5 <sup>1</sup> / <sub>2</sub>	STD FORGE
4607	12 <sup>1</sup> / <sub>4</sub> X 7 <sup>1</sup> / <sub>2</sub>	STD FORGE
4661FCII	12 <sup>1</sup> / <sub>4</sub> X 5	FCII
4692FCII	12 <sup>1</sup> / <sub>4</sub> X 7 <sup>1</sup> / <sub>2</sub>	FCII

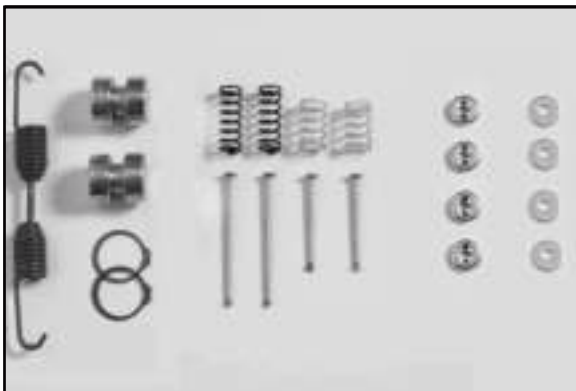

### Kit Number: SKSTHK50

SKST No.	Description	Qty.
19-896	Return Spring	1
19-921	Hold Down Assembly	2
32-1464	Cam Roller - Smooth	2
34-1525	Camshaft Lockring	2

#### Application

1307T	15 X 3 <sup>1</sup> / <sub>2</sub>	ROCKWELL T
1308T	15 X 4	ROCKWELL / MERITOR T



### Kit Number: SKSTHK51

SKST No.	Description	Qty.
15-550	Anchor Pin	2
19-896	Return Spring	1
19-921	Hold Down Assembly	2
32-1464	Cam Roller - Smooth	2
34-1525	Camshaft Lockring	2
34-1551	Anchor Pin Hex Nut	2
34-1552	Anchor Pin Washer	2

#### Application

1307T	15 X 3 <sup>1</sup> / <sub>2</sub>	ROCKWELL T
1308T	15 X 4	ROCKWELL / MERITOR T



## BRAKE HARDWARE KITS

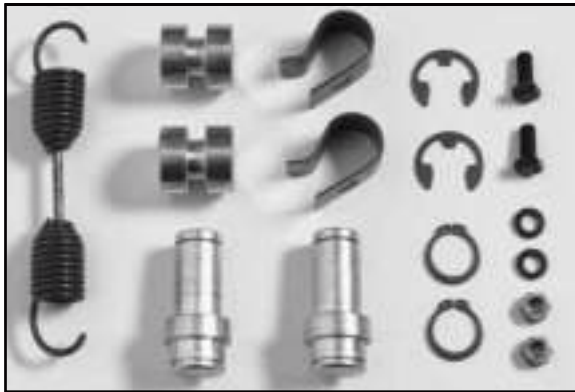

### Application

4561      16 1/4 X 3 1/2      ROCKWELL T

### Kit Number: SKSTHK52

SKST No.	Description	Qty.
15-551	Anchor Pin	2
19-862	Return Spring - Heavy Duty	1
19-920	Hold Down Assembly	2
32-1465	Cam Roller - Smooth	2
34-1543	Anchor Pin Lock Ring	2
34-1549	Anchor Pin Lock	2



### Application

1308A      15 X 4      WAGNER

### Kit Number: SKSTHK53

SKST No.	Description	Qty.
15-557	Anchor Pin	2
19-891	Return Spring	1
19-892A	Hold Down Assembly	4
32-1463	Cam Roller - Smooth	2
34-1550	Anchor Pin Lock	2
34-1551	Anchor Pin Hex Nut	2



### Application

1308E      15 X 4      SAP  
1443E      15 X 4      ESII

### Kit Number: SKSTHK54

SKST No.	Description	Qty.
19-922	Retainer Spring	1
19-923	Return Spring	1
32-1464	Cam Roller - Smooth	2

## BRAKE HARDWARE KITS



### Kit Number: SKSTHK55

SKST No.	Description	Qty.
15-562	Anchor Pin	2
19-902	Return Spring	1
19-903	Retainer Spring	1
19-920	Hold Down Assembly	2
32-1464	Cam Roller - Smooth	2
34-1551	Anchor Pin Hex Nut	2
34-1561	Anchor Pin Plate	1
34-1562	Anchor Pin Washer	2

#### Application

1307Q	15 X 3 1/2	ROCKWELL Q
1308Q	15 X 4	ROCKWELL / MERITOR Q
1308Q	15 X 4	FC



### Kit Number: SKSTHK56

SKST No.	Description	Qty.
15-555	Anchor Pin	2
19-890	Return Spring	1
19-892A	Hold Down Assembly	4
32-1462	Cam Roller - Smooth	2
34-1550	Anchor Pin Lock	2
34-1551	Anchor Pin Hex Nut	2

#### Application

235-1245	15 X 3	WAGNER
----------	--------	--------



### Kit Number: SKSTHK57

SKST No.	Description	Qty.
15-556	Anchor Pin	2
19-890	Return Spring	1
19-892A	Hold Down Assembly	4
32-1462	Cam Roller - Smooth	2
34-1550	Anchor Pin Lock	2
34-1551	Anchor Pin Hex Nut	2

#### Application

463-1280	15 X 3 1/2	WAGNER
----------	------------	--------

## BRAKE HARDWARE KITS



### Kit Number: SKSTHK58XLS

SKST No.	Description	Qty.
15-542	Anchor Pin	2
16-563	Anchor Pin Bushing - Stainless Steel	2
19-862	Return Spring - Heavy Duty	1
19-941	Retainer Spring - 12 <sup>1</sup> / <sub>4</sub> 2	
20-881	Return Spring Pin	2
32-1445	Cam Roller - Knurled	2
32-1446	Cam Roller Pin	2
34-1526	Lockring	2

#### Application

4692FC 12<sup>1</sup>/<sub>4</sub> X 7<sup>1</sup>/<sub>2</sub> DEXTER PQ



### Kit Number: SKSTHK59

SKST No.	Description	Qty.
15-568	Anchor Pin	2
19-891	Return Spring	1
19-892A	Hold Down Assembly	4
32-1462	Cam Roller - Smooth	2
34-1550	Anchor Pin Lock	2
34-1551	Anchor Pin Hex Nut	2

#### Application

512 15 X 4 WAGNER



### Kit Number: SKSTHK60

SKST No.	Description	Qty.
15-541	Anchor Pin	2
19-884	Return Spring	1
32-1460	Cam Roller Pin	2
32-1461	Cam Roller - Smooth	2
34-1525	Camshaft Lockring	4
35-1582	Neoprene Anchor Pin Seal	4

#### Application

380-4596 15 X 6 WAGNER  
382-4597 15 X 7 WAGNER

## BRAKE HARDWARE KITS

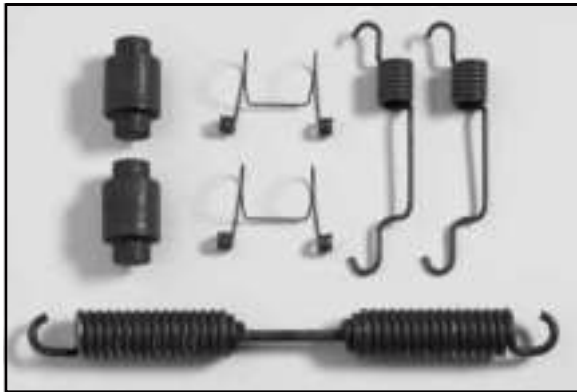

### Kit Number: SKSTHK61

SKST No.	Description	Qty.
19-915	Return Spring - Heavy Duty	1
19-940	Retainer Spring - 16 <sup>1</sup> / <sub>2</sub> & 15	2
32-1490	Cam Roller - Unplated - Smooth	2
34-1570	Cam Roller Retainer	2

#### Application

4709EII	16 <sup>1</sup> / <sub>2</sub> X 7	ESII
4726EII	16 <sup>1</sup> / <sub>2</sub> X 8 <sup>5</sup> / <sub>8</sub>	ESII



### Kit Number: SKSTHK61SD

SKST No.	Description	Qty.
19-915	Return Spring - Heavy Duty	1
19-940	Retainer Spring - 16 <sup>1</sup> / <sub>2</sub> & 15	2
32-1471	Cam Roller - Knurled	2
34-1570	Cam Roller Retainer	2
Antiseize	Hw Kit Lubricant	1

#### Application

4709EII	16 <sup>1</sup> / <sub>2</sub> X 7	ESII
4726EII	16 <sup>1</sup> / <sub>2</sub> X 8 <sup>5</sup> / <sub>8</sub>	ESII



### Kit Number: SKSTHK61XLS

SKST No.	Description	Qty.
19-915	Return Spring - Heavy Duty	1
19-940	Retainer Spring - 16 <sup>1</sup> / <sub>2</sub> & 15	2
32-1471	Cam Roller - Knurled	2
34-1570	Cam Roller Retainer	2

#### Application

4709EII	16 <sup>1</sup> / <sub>2</sub> X 7	ESII
4726EII	16 <sup>1</sup> / <sub>2</sub> X 8 <sup>5</sup> / <sub>8</sub>	ESII

## BRAKE HARDWARE KITS

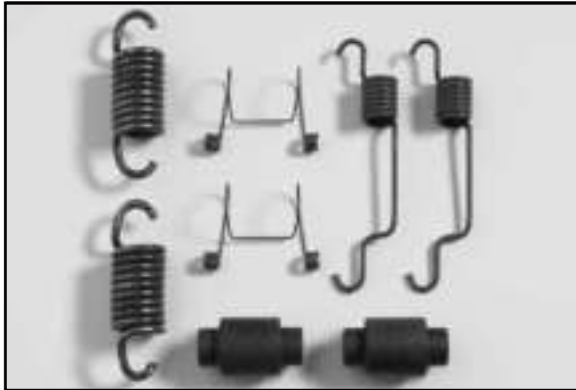

### Application

4719EII	16 $\frac{1}{2}$ X 5	ESII
4725EII	16 $\frac{1}{2}$ X 6	ESII

### Kit Number: SKSTHK62

SKST No.	Description	Qty.
19-924	Return Spring - Heavy Duty	2
19-940	Retainer Spring - 16 $\frac{1}{2}$ & 15	2
32-1490	Cam Roller - Unplated - Smooth	2
34-1570	Cam Roller Retainer	2



### Application

4719EII	16 $\frac{1}{2}$ X 5	ESII
4725EII	16 $\frac{1}{2}$ X 6	ESII

### Kit Number: SKSTHK62SD

SKST No.	Description	Qty.
19-924	Return Spring - Heavy Duty	2
19-940	Retainer Spring - 16 $\frac{1}{2}$ & 15	2
32-1471	Cam Roller - Knurled	2
34-1570	Cam Roller Retainer	2
Antiseize	Hw Kit Lubricant	1



### Application

4719EII	16 $\frac{1}{2}$ X 5	ESII
4725EII	16 $\frac{1}{2}$ X 6	ESII

### Kit Number: SKSTHK62XLS

SKST No.	Description	Qty.
19-924	Return Spring - Heavy Duty	2
19-940	Retainer Spring - 16 $\frac{1}{2}$ & 15	2
32-1471	Cam Roller - Knurled	2
34-1570	Cam Roller Retainer	2

## BRAKE HARDWARE KITS

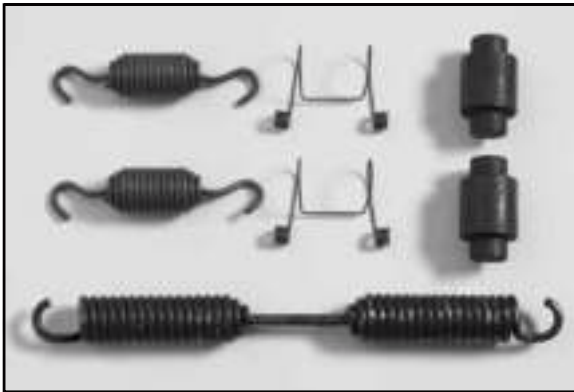

### Kit Number: SKSTHK63

SKST No.	Description	Qty.
19-859	Retainer Spring	2
19-915	Return Spring - Heavy Duty	1
32-1490	Cam Roller - Unplated - Smooth	2
34-1570	Cam Roller Retainer	2

#### Application

4709	16½ X 7	ES
4719	16½ X 5	ES
4725	16½ X 5	ES



### Kit Number: SKSTHK63SD

SKST No.	Description	Qty.
19-859	Retainer Spring	2
19-915	Return Spring - Heavy Duty	1
32-1471	Cam Roller - Knurled	2
34-1570	Cam Roller Retainer	2
Antiseize	Hw Kit Lubricant	1

#### Application

4709	16½ X 7	ES
4719	16½ X 5	ES
4725	16½ X 5	ES

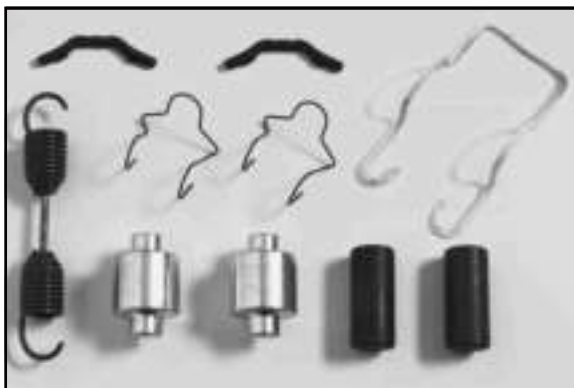

### Kit Number: SKSTHK47XLS-150

SKST No.	Description	Qty.
15-545	Anchor Pin	2
19-862	Return Spring - Heavy Duty	1
20-881	Return Spring Pin	2
32-1427	Cam Roller - Smooth	2
34-1532	Cam Roller Retainer - Rockwell	2
34-1563	Anchor Pin Retainer	1

#### Application

4536E	12¼ X 5½	U BRAKE
4692	12¼ X 7½	U BRAKE

## BRAKE HARDWARE KITS

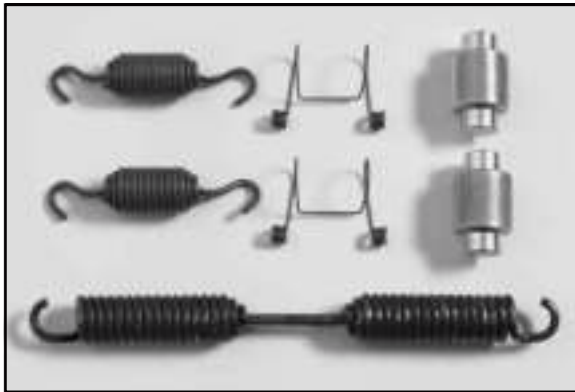

### Kit Number: SKSTHK63XLS

SKST No.	Description	Qty.
19-859	Retainer Spring	2
19-915	Return Spring - Heavy Duty	1
32-1471	Cam Roller - Knurled	2
34-1570	Cam Roller Retainer	2

#### Application

4709	16 $\frac{1}{2}$ X 7	ES
4719	16 $\frac{1}{2}$ X 5	ES
4725	16 $\frac{1}{2}$ X 5	ES



### Kit Number: SKSTHK64XLS

SKST No.	Description	Qty.
19-859	Retainer Spring	2
19-875	Return Spring	1
32-1441A	Cam Roller - Knurled	2
32-1442A	Cam Roller Pin	2

#### Application

4223E	16 $\frac{1}{2}$ X 5	SAP
4317E	16 $\frac{1}{2}$ X 6	SAP



### Kit Number: SKSTHK65SD

SKST No.	Description	Qty.
12-403	Cotter Pin	1
15-536	Anchor Pin	2
16-700	Anchor Pin Bushing - Dimpled Stainless Steel	2
19-860	Return Spring	2
19-930	Return Spring - Heavy Duty	1
20-881	Return Spring Pin	2
32-1428	Cam Roller - Knurled	2
34-1570	Cam Roller Retainer	2
Antiseize	Hw Kit Lubricant	1

#### Application

4708XEM	16 $\frac{1}{2}$ X 7	FRUEHAUF "XEM"
4708XEM	16 $\frac{1}{2}$ X 7	ESII

## BRAKE HARDWARE KITS

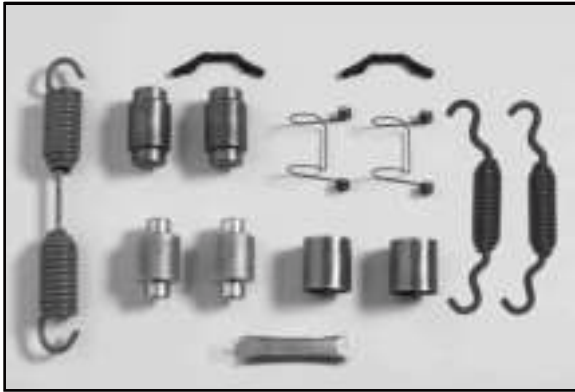

### Kit Number: SKSTHK67SD

SKST No.	Description	Qty.
15-542	Anchor Pin	2
16-700	Anchor Pin Bushing - Dimpled Stainless Steel	2
19-860	Return Spring	2
19-930	Return Spring - Heavy Duty	1
20-881	Return Spring Pin	2
32-1428	Cam Roller - Knurled	2
34-1570	Cam Roller Retainer	2
Antiseize	Hw Kit Lubricant	1

#### Application

4708Q	16½ X 7	ROCKWELL "Q"
4708Q	16½ X 7	ESII

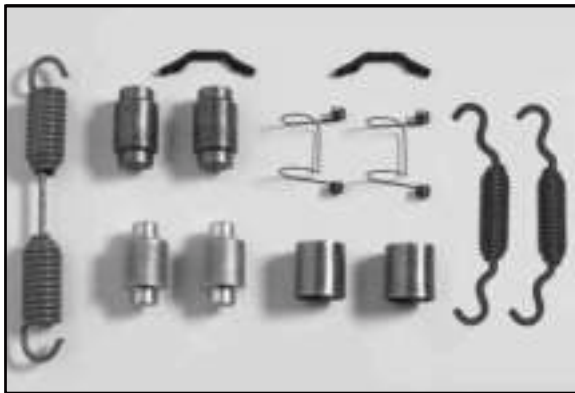

### Kit Number: HK67XLS

SKST No.	Description	Qty.
15-542	Anchor Pin	2
16-700	Anchor Pin Bushing - Dimpled Stainless Steel	2
19-860	Return Spring	2
19-930	Return Spring - Heavy Duty	1
20-881	Return Spring Pin	2
32-1428	Cam Roller - Knurled	2
34-1570	Cam Roller Retainer	2

#### Application

4708Q	16½ X 7	ROCKWELL "Q"
4708Q	16½ X 7	ESII



### Kit Number: SKSTHK68

SKST No.	Description	Qty.
15-532	Anchor Pin	2
19-865	Return Spring	1
23-1026	Brake Shoe Bushing	4
32-1458	Cam Roller - Smooth	2
34-1525	Camshaft Lockring	4
34-1539	Anchor Pin Lock Screw	2
34-1565	Spring Retainer	2
35-1582	Neoprene Anchor Pin Seal	4

#### Application

4471B	18 X 7	ROCKWELL CAST
-------	--------	---------------



## BRAKE HARDWARE KITS



### Kit Number: SKSTHK69XLS

SKST No.	Description	Qty.
15-527	Anchor Pin	2
16-563	Anchor Pin Bushing - Stainless Steel	2
19-930	Return Spring - Heavy Duty	1
20-881	Return Spring Pin	2
32-1428	Cam Roller - Knurled	2
34-1525	Camshaft Lockring	4
34-1570	Cam Roller Retainer	2
35-1580	Anchor Pin Washer	4

#### Application

4708P 16½ X 7 ROCKWELL "P"



### Kit Number: SKSTHK70

SKST No.	Description	Qty.
15-563	Anchor Pin	1
19-904	Return Spring	1
19-905	Retainer Spring	2
32-1479	Cam Roller - Smooth	2
32-1480	Cam Roller Pin	2

#### Application

4693 15 X 4



### Kit Number: SKSTHK71

SKST No.	Description	Qty.
15-564	Anchor Pin	2
16-566	Anchor Pin Bushing	2
19-906	Return Spring	1
19-907	Retainer Spring	2
20-881	Return Spring Pin	2
32-1479	Cam Roller - Smooth	2
32-1480	Cam Roller Pin	2

#### Application

4515E 16½ X 7

## BRAKE HARDWARE KITS



### Kit Number: SKSTHK72

SKST No.	Description	Qty.
15-602	Anchor Pin	2
16-562	Anchor Pin Bushing	2
16-701	Shoe Bushing	4
19-939	Return Spring	1
32-1563	Cam Roller	2
32-1564	Cam Roller Pin	2
34-1525	Camshaft Lockring	4
34-1583	Lock Screw	2
34-1584	Lock Pin	2
35-1580	Anchor Pin Washer	4

#### Application

4708H 16 $\frac{1}{2}$  X 7

CAST



### Kit Number: SKSTHK73

SKST No.	Description	Qty.
15-603	Anchor Pin	2
16-562	Anchor Pin Bushing	2
19-954	Return Spring	1
20-881	Return Spring Pin	2
32-1425	Cam Roller - Smooth	2
34-1525	Camshaft Lockring	4
34-1570	Cam Roller Retainer	2
34-1583	Lock Screw	2
35-1580	Anchor Pin Washer	4

#### Application

4708M 16 $\frac{1}{2}$  X 7

SEVERE DUTY



### Kit Number: SKSTHK75SD

SKST No.	Description	Qty.
15-532	Anchor Pin	2
19-853	Return Spring - Heavy Duty	1
20-881	Return Spring Pin	2
23-1026	Brake Shoe Bushing	4
32-1428	Cam Roller - Knurled	2
34-1525	Camshaft Lockring	4
34-1532	Cam Roller Retainer - Rockwell	2
34-1539	Anchor Pin Lock Screw	2
35-1582	Neoprene Anchor Pin Seal	4
Antiseize	Hw Kit Lubricant	1

#### Application

4515M 16 $\frac{1}{2}$  X 7

MACK FABRICATED

## BRAKE HARDWARE KITS

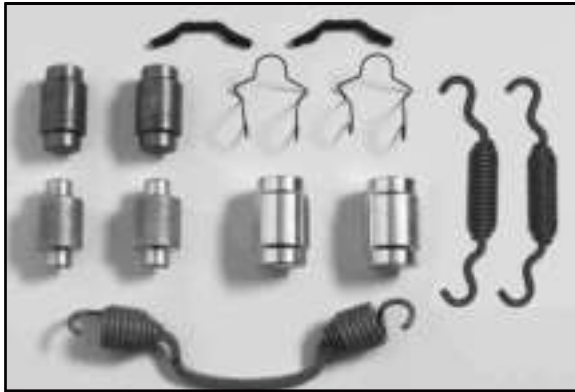

### Kit Number: SKSTHK74XLS

SKST No.	Description	Qty.
15-542	Anchor Pin	2
16-563	Anchor Pin Bushing - Stainless Steel	2
19-860	Return Spring	2
19-950	Return Spring - Heavy Duty	1
20-881	Return Spring Pin	2
32-1428	Cam Roller - Knurled	2
34-1532	Cam Roller Retainer - Rockwell	2

#### Application

4514Q	16 $\frac{1}{2}$ X 6	ROCKWELL / MERITOR Q
4514Q	16 $\frac{1}{2}$ X 6	FC
4524Q	16 $\frac{1}{2}$ X 5	ROCKWELL / MERITOR Q
4524Q	16 $\frac{1}{2}$ X 5	FC
4715R	16 $\frac{1}{2}$ X 6	ROCKWELL / MERITOR Q PLUS
4715R	16 $\frac{1}{2}$ X 6	XTRALIFE II
4720R	16 $\frac{1}{2}$ X 5	ROCKWELL / MERITOR Q PLUS
4720R	16 $\frac{1}{2}$ X 5	XTRALIFE II



### Kit Number: SKSTHK76

SKST No.	Description	Qty.
15-532	Anchor Pin	2
16-562	Anchor Pin Bushing	2
19-878	Return Spring	1
23-1026	Brake Shoe Bushing	4
32-1458	Cam Roller - Smooth	2
34-1525	Camshaft Lockring	4
34-1539	Anchor Pin Lock Screw	2
35-1582	Neoprene Anchor Pin Seal	4

#### Application

4669D	18 X 7	ROCKWELL CAST IRON
-------	--------	--------------------

## BRAKE HARDWARE KITS

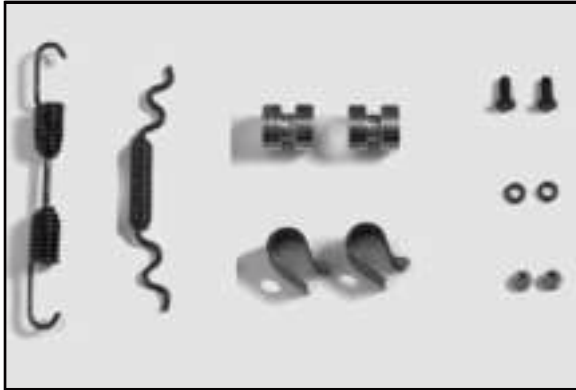

### Kit Number: SKSTHK77

SKST No.	Description	Qty.
19-902	Return Spring	1
19-903	Retainer Spring	1
19-920	Hold Down Assembly	2
32-1464	Cam Roller - Smooth	2

#### Application

1307Q	15 X 3 1/2	ROCKWELL Q
1308Q	15 X 4	ROCKWELL / MERITOR Q
1308Q	15 X 4	FC



### Kit Number: SKSTHK80XLS

SKST No.	Description	Qty.
15-542	Anchor Pin	2
16-563	Anchor Pin Bushing - Stainless Steel	2
19-860	Return Spring	2
19-913	Return Spring	1
20-881	Return Spring Pin	2
32-1428	Cam Roller - Knurled	2
34-1529	Cam Roller Retainer	2

#### Application

4514Q	16 1/2 X 6	ROCKWELL / MERITOR Q
4514Q	16 1/2 X 6	FC
4524Q	16 1/2 X 5	ROCKWELL / MERITOR Q
4524Q	16 1/2 X 5	FC



### Kit Number: SKSTHK82SD

SKST No.	Description	Qty.
15-565	Anchor Pin	2
16-700	Anchor Pin Bushing - Dimpled Stainless Steel	2
19-853A	Return Spring - Heavy Duty	1
19-900	Retainer Spring	2
20-881	Return Spring Pin	2
20-886	Return Spring Pin	2
29-1342	Spring Retainer Lock Ring	2
32-1475	Cam Roller - Smooth	2
34-1532	Cam Roller Retainer - Rockwell	2
Antiseize	HW Kit Lubricant	1+

#### Application

4515QM	16 1/2 X 7	ROCKWELL MACK STYLE
--------	------------	---------------------

## BRAKE HARDWARE KITS



### Kit Number: SKSTHK81XLS

SKST No.	Description	Qty.
15-542	Anchor Pin	2
16-563	Anchor Pin Bushing - Stainless Steel	2
19-860	Return Spring	2
19-910	Return Spring	1
20-881	Return Spring Pin	2
32-1428	Cam Roller - Knurled	2
34-1529	Cam Roller Retainer	2

#### Application

4514Q	16½ X 6	ROCKWELL / MERITOR Q
4514Q	16½ X 6	FC
4524QM	16½ X 5	ROCKWELL / MERITOR Q
4524QM	16½ X 5	FC

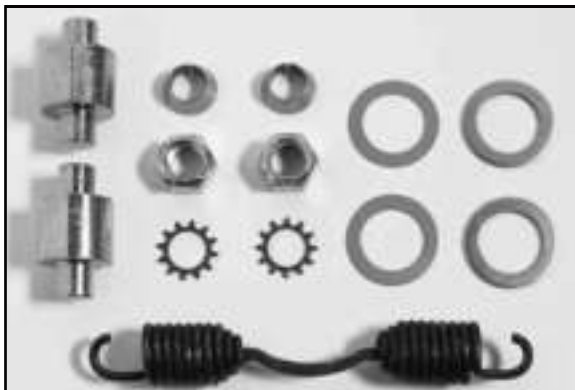

### Kit Number: SKSTHK83

SKST No.	Description	Qty.
16-703	Anchor Pin Bushing	2
19-953	Return Spring	1
29-1404	Camshaft Washer	2
29-1407	Camshaft Washer	2
29-1408	Lock Washer	2
32-1561	Shoe Roller	2
51-1020	Anchor Pin Nut	2

#### Application

4592A	14½ X 10	ROCKWELL COACH
-------	----------	----------------



### Kit Number: SKSTHK84

SKST No.	Description	Qty.
15-601	Anchor Pin	2
16-702	Anchor Pin Bushing	2
19-953	Return Spring	1
29-1405	Snap Ring	4
32-1562	Cam Roller	2
34-1585	Bolt	2

#### Application

4592A	14½ X 10	ROCKWELL COACH
-------	----------	----------------

## BRAKE HARDWARE KITS

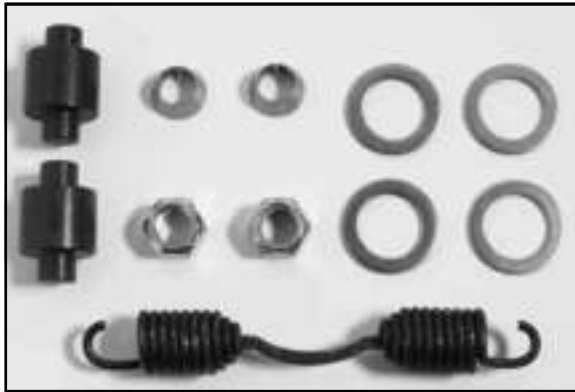

### Kit Number: SKSTHK85

SKST No.	Description	Qty.
16-703	Anchor Pin Bushing	2
19-953	Return Spring	1
29-1402	Camshaft Washer	2
29-1403	Camshaft Washer	2
32-1575	Shoe Roller	2
51-1020	Anchor Pin Nut	2

#### Application

4541B 14½ X 8 ROCKWELL COACH



### Kit Number: SKSTHK86

SKST No.	Description	Qty.
19-952	Return Spring	2
29-1401	Lock Washer	2
29-1409	Lock Bolt	2
32-1560	Shoe Roller	2

#### Application

4398B 14½ X 5 ROCKWELL COACH



### Kit Number: SKSTHK90XLS

SKST No.	Description	Qty.
19-860	Return Spring	2
19-924	Return Spring - Heavy Duty	2
32-1471	Cam Roller - Knurled	2
34-1570	Cam Roller Retainer	2

#### Application

4716EII 15 X 6 REDUCED ENVELOPE

## BRAKE HARDWARE KITS



### Kit Number: SKSTHK87

SKST No.	Description	Qty.
15-600	Anchor Pin	2
19-952	Return Spring	2
29-1409	Lock Bolt	1
30-1400	Lock Plate	1
32-1560	Shoe Roller	2
34-1525	Camshaft Lockring	4

#### Application

4227G	14 <sup>1</sup> / <sub>2</sub> X 4	ROCKWELL COACH
4228B	14 <sup>1</sup> / <sub>2</sub> X 6	ROCKWELL COACH

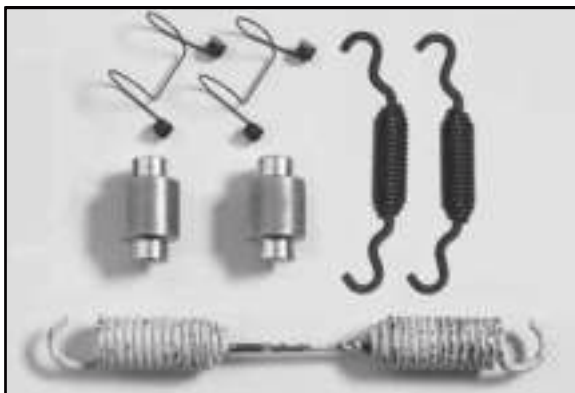

### Kit Number: SKSTHK91XLS

SKST No.	Description	Qty.
19-860	Return Spring	2
19-925	Return Spring - Heavy Duty	1
32-1471	Cam Roller - Knurled	2
34-1570	Cam Roller Retainer	2

#### Application

4717EII	15 X 8 <sup>5</sup> / <sub>8</sub>	REDUCED ENVELOPE
---------	------------------------------------	------------------



### Kit Number: SKSTHK95XLS

SKST No.	Description	Qty.
19-853	Return Spring - Heavy Duty	1
19-860	Return Spring	2
19-934	Return Spring	1
20-881	Return Spring Pin	2
20-887	Return Spring Pin	2
20-888	Return Spring Pin	2
32-1427	Cam Roller - Smooth	2
34-1529	Cam Roller Retainer	2

#### Application

4514HA	16 <sup>1</sup> / <sub>2</sub> X 6	HEAVY AXLE
4515HA	16 <sup>1</sup> / <sub>2</sub> X 7	HEAVY AXLE
4524HA	16 <sup>1</sup> / <sub>2</sub> X 5	HEAVY AXLE
4693HA	15 X 4	HEAVY AXLE

## BRAKE HARDWARE KITS

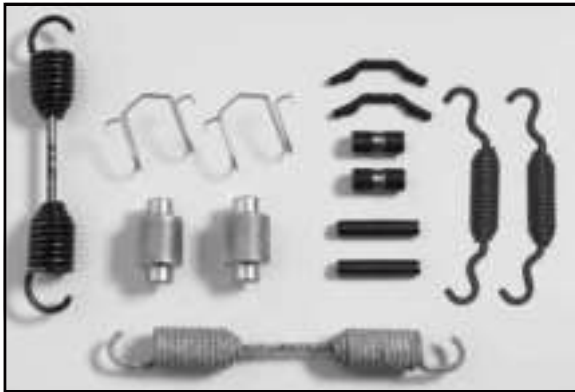

### Kit Number: SKSTHK96XLS

SKST No.	Description	Qty.
19-853	Return Spring - Heavy Duty	1
19-860	Return Spring	2
19-935	Return Spring	1
20-881	Return Spring Pin	2
20-887	Return Spring Pin	2
20-888	Return Spring Pin	2
32-1428	Cam Roller - Knurled	2
34-1529	Cam Roller Retainer	2

#### Application

4701HA 16½ X 7

HEAVY AXLE



### Kit Number: SKSTHK97XLS

SKST No.	Description	Qty.
19-940	Retainer Spring - 16½ & 15	0
19-956	RETURN SPRING	1
32-1471	Cam Roller - Knurled	2
34-1570	Cam Roller Retainer	2

#### Application

4729EII 15 X 4

ESII



## BRAKE SPRINGS

B.P.W.



REF.: 8SKS - 916  
MED.: 181 x 22 x Ø3,2  
REF. ORIG.: 0339734100



REF.: 6SKS - 345  
MED.: 145 x 26 x Ø4  
REF. ORIG.: 0539726030



REF.: 6SKS - 322  
MED.: 233 x 22 x Ø4  
REF. ORIG.: 0539726020



REF.: 6SKS - 320  
MED.: 105 x 21 x Ø4  
REF. ORIG.: 0339744060



REF.: SKS - 009  
MED.: 101 x 21 x Ø3,5  
REF. ORIG.: 0339734010



REF.: 6SKS -313  
MED.: 120 x 29,5 x Ø2,8  
REF. ORIG.: 0539728010



REF.: 6SKS - 324  
MED.: 106 x 21,5 x Ø4  
REF. ORIG.: 0539745100



REF.: 6SKS - 314  
MED.: 155 x 22 x Ø4  
REF. ORIG.: 0539745050

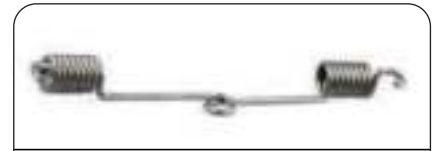

REF.: 4SKS - 028  
MED.: 220 x 20 x Ø3,6  
REF. ORIG.: 0339735050



REF.: 4SKS - 029  
MED.: 167 x 20 x Ø3.6  
REF. ORIG.: 0539734160



REF.: 6SKS - 344  
MED.: 180 x 22,5 x Ø4  
REF. ORIG.: 0539726050

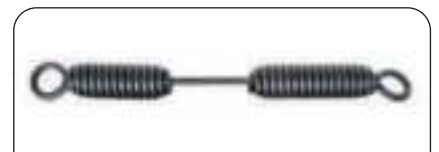

REF.: 6SKS - 326  
MED.: 265 x 24 x Ø6  
REF. ORIG.: 0539746030



REF.: 6SKS - 321  
MED.: 217 x 24 x Ø4  
REF. ORIG.: 0539745140

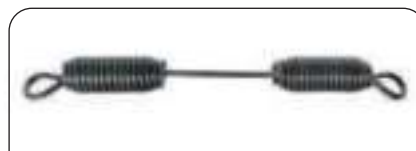

REF.: 6SKS - 342  
MED.: 257 x 25 x Ø4,8  
REF. ORIG.: 0539746070



REF.: 6SKS - 318 (15")  
MED.: 161 x 22 x Ø3,5  
REF. ORIG.: 0539735030

## BRAKE SPRINGS B.P.W.

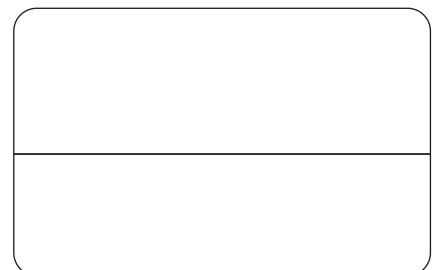
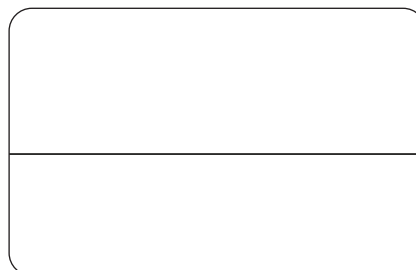
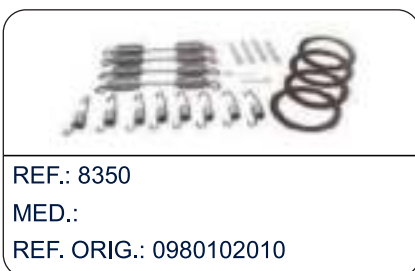
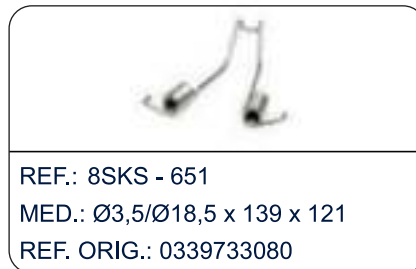
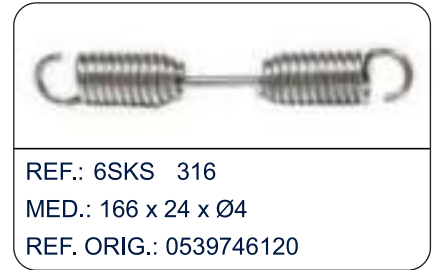
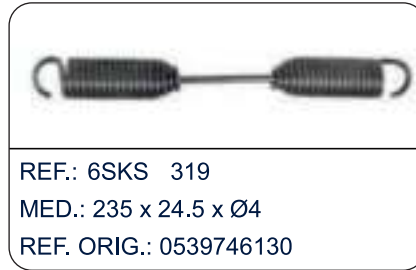

## BRAKE SPRINGS DAF



REF.: 8SKS - 649  
MED.: 227 x 28 x Ø4,3  
REF. ORIG.: 194592



REF.: 8SKS - 648  
MED.: 196 x 19 x Ø3  
REF. ORIG.: 0191530



REF.: SKS - 017  
MED.: 155 x 39 x Ø5,3  
REF. ORIG.: 1212994



REF.: 8SKS - 650  
MED.: 244 x 28 x Ø4  
REF. ORIG.: 0672797



REF.: 3SKS - 494  
MED.: 230 x 30 x Ø5  
REF. ORIG.:



REF.: 3SKS - 475  
MED.: 198 x 26 x Ø5  
REF. ORIG.:

## FRUEHAUF



REF.: SKS - 021  
MED.: 165 x 25 x Ø3  
REF. ORIG.:



REF.: SKS - 022  
MED.: 224 x 25 x Ø3  
REF. ORIG.: MD19959



REF.:  
MED.: 183 x 28 x Ø4/Ø6  
REF. ORIG.: 7000107D



REF.: 8SKS - 704  
MED.: 177 x 28 x Ø3.8  
REF. ORIG.: AJA-0487001 / M007150



REF.: 6SKS - 349  
MED.: 202 x 32 x Ø5  
REF. ORIG.: AJB-0119-001 / M-002874



REF.: SKS - 023  
MED.: 200 x 27 x Ø4  
REF. ORIG.: 31431 / 10335

## BRAKE SPRINGS FRENELSA

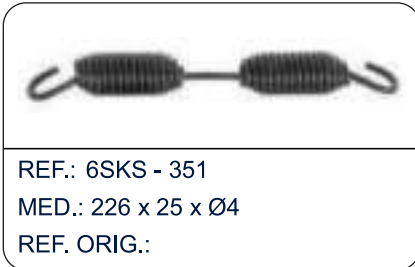

## IVECO

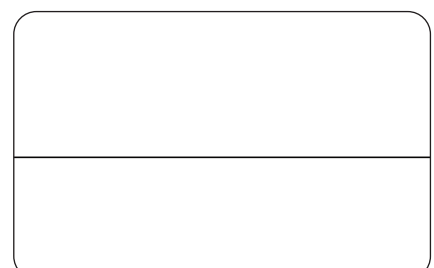
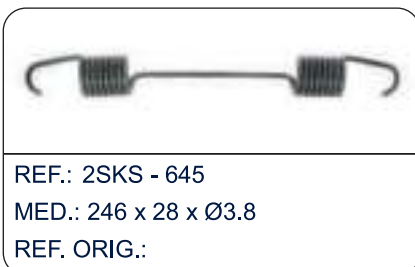
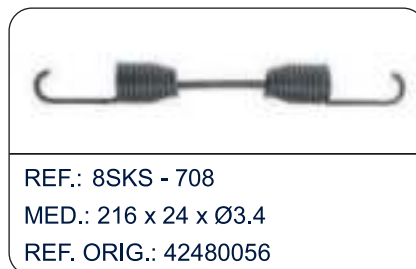
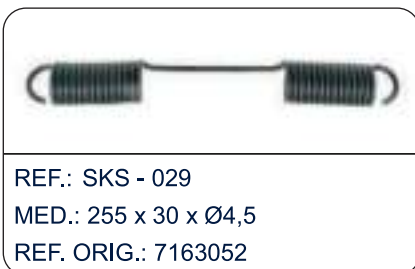

## LECIÑENA

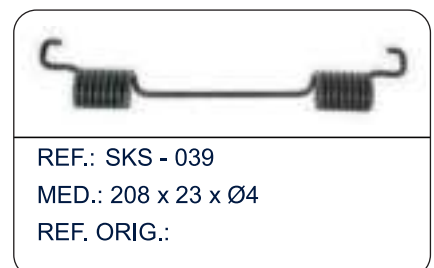

## BRAKE SPRINGS



REF.: SKS - 040  
MED.: 174 x 25 x Ø4  
REF. ORIG.: 3126635000



REF.: SKS - 041  
MED.: 228 x 18 x Ø3  
REF. ORIG.:



REF.: SKS - 042  
MED.: 217 x 24 x Ø4  
REF. ORIG.: 05397445140

## MAN



REF.: 8SKS - 707  
MED.: 239 x 26 x Ø4  
REF. ORIG.: 81976100123



REF.: SKS - 044  
MED.: 240 x 28,5 x Ø4,5  
REF. ORIG.: 81976100118



REF.: 8SKS - 645  
MED.: 244 x 30 x Ø5  
REF. ORIG.: 81976100266



REF.: 8SKS - 645  
MED.: 240 x 30 x Ø5  
REF. ORIG.: 81976100271



REF.: 8SKS- 707  
MED.: 239 x 26 x Ø4  
REF. ORIG.: 81976100115 / 123

## RETROCESO PALANCA



REF.: 5SKS - 618  
MED.: 212 x 27 x Ø3  
REF. ORIG.: 81976100001



REF.: 8SKS - 658  
MED.: 227 x 30.5 x Ø4.25  
REF. ORIG.: 81976100210



REF.: R10686  
MED.: 246 x 26 x Ø4  
REF. ORIG.: 81976100208

## BRAKE SPRINGS

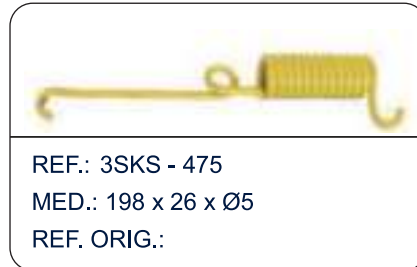

## MERCEDES

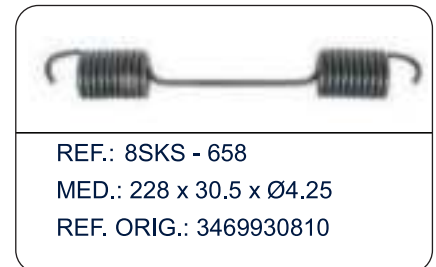
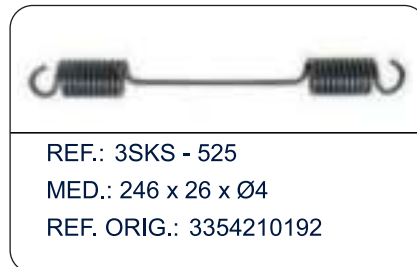
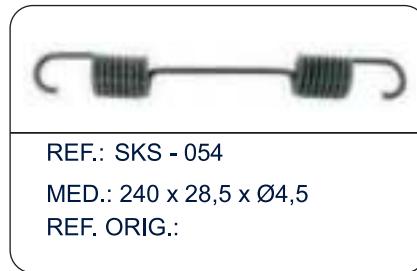

## RETROCESO PALANCA

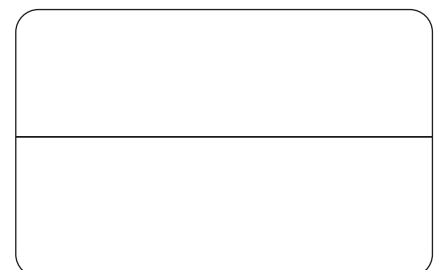
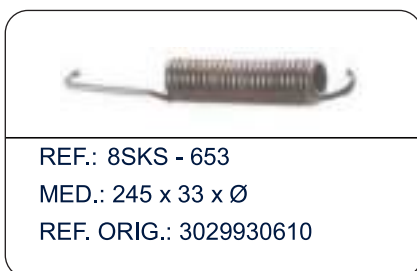

## BRAKE SPRINGS MONTENEGRO

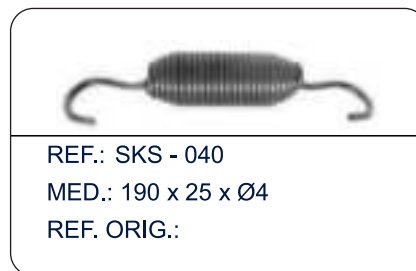
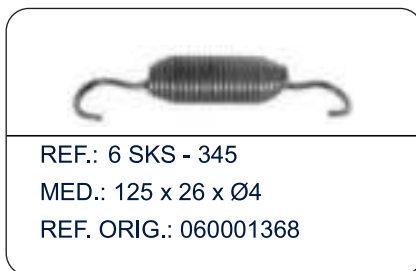

## NISSAN - EBRO



## PEGASO

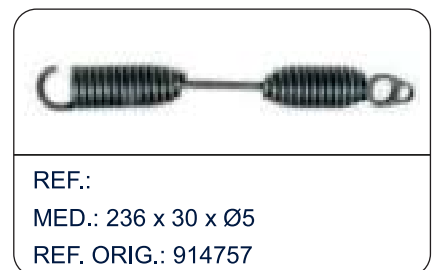

## BRAKE SPRINGS

### R.O.R.



### RETROCESO PALANCA

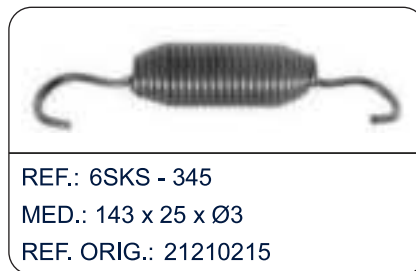

### R.V.I.

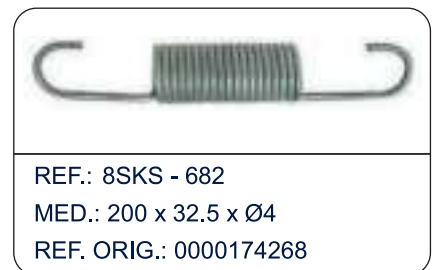
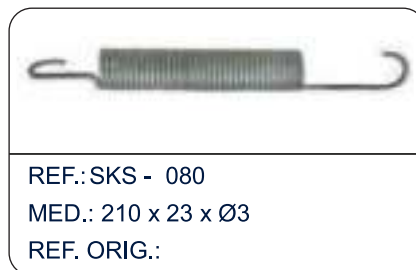



## BRAKE SPRINGS



### SAF – SAUER ACHEN



### RETROCESO PALANCA

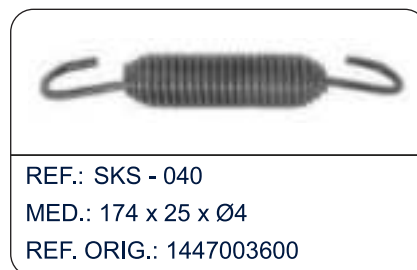
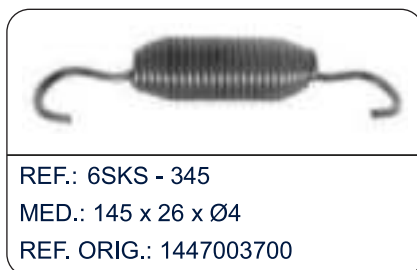

## BRAKE SPRINGS

### SCANIA



### SMB



### TRAVOSA



### TRAILOR



## BRAKE SPRINGS

### VOLVO

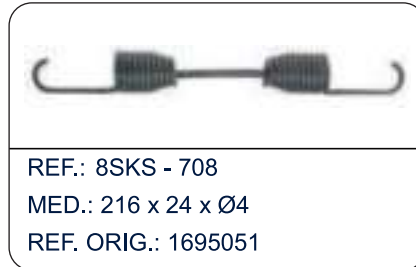

### YORK

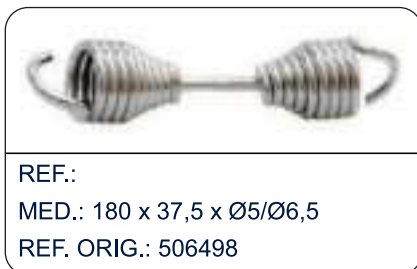

## AGRICULTURE VEHICLE SPRINGS

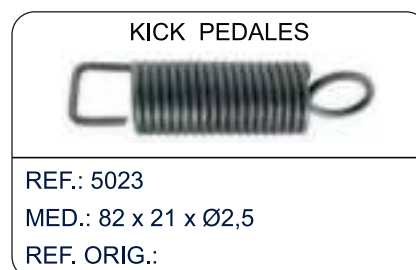
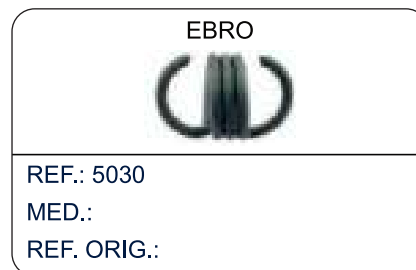

## BRAKE SHOE REPAIR KIT



### Brake Shoe Repair Kit (070.545 )

Code	070.545
OEM Number	0908446350
Suitable for	BPW
Packing Weight	1.31 KG
Quantity in Pallet	0
Quantity in Box	1



### Brake Shoe Repair Kit (075.535 )

Code	075.535
OEM Number	5000816353
Suitable for	RENAULT TRUCKS SAF
Packing Weight	2.94 KG
Quantity in Pallet	852
Quantity in Box	6



### Brake Shoe Repair Kit (040.533 )

Code	040.533
OEM Number	154259S
Suitable for	SCANIA
Packing Weight	1.44 KG
Quantity in Pallet	376
Quantity in Box	2



### Brake Shoe Repair Kit (070.524 )

Code	070.524
OEM Number	0980102110S
Suitable for	BPW
Packing Weight	2.76 KG
Quantity in Pallet	0
Quantity in Box	6

## BRAKE SHOE REPAIR KIT

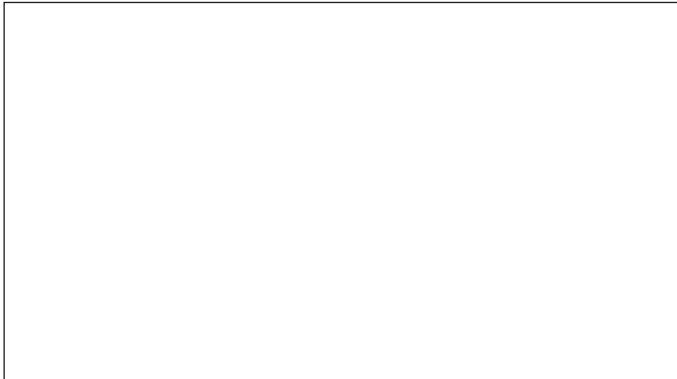

### Brake Shoe Repair Kit (075.566 )

Code	075.566
OEM Number	-
Suitable for	SAF
Packing Weight	2.29 KG
Quantity in Pallet	0
Quantity in Box	1



### Brake Shoe Repair Kit (070.559 )

Code	070.559
OEM Number	0908446120
Suitable for	BPW
Packing Weight	1.12 KG
Quantity in Pallet	0
Quantity in Box	1



### Brake Shoe Repair Kit (075.563 )

Code	075.563
OEM Number	3434361200
Suitable for	SAF
Packing Weight	2.70 KG
Quantity in Pallet	0
Quantity in Box	1



### Brake Shoe Repair Kit (090.509 )

Code	090.509
OEM Number	ARJA0199703
Suitable for	FRUEHAUF
Packing Weight	3.70 KG
Quantity in Pallet	0
Quantity in Box	1

## BRAKE SHOE REPAIR KIT



**Brake Shoe Repair Kit (070.556/1 )**

Code	070.556/1
OEM Number	0980102910S
Suitable for	BPW
Packing Weight	5.60 KG
Quantity in Pallet	0
Quantity in Box	10



**Brake Shoe Repair Kit (075.533 )**

Code	075.533
OEM Number	3434360200
Suitable for	SAF
Packing Weight	4.78 KG
Quantity in Pallet	0
Quantity in Box	1

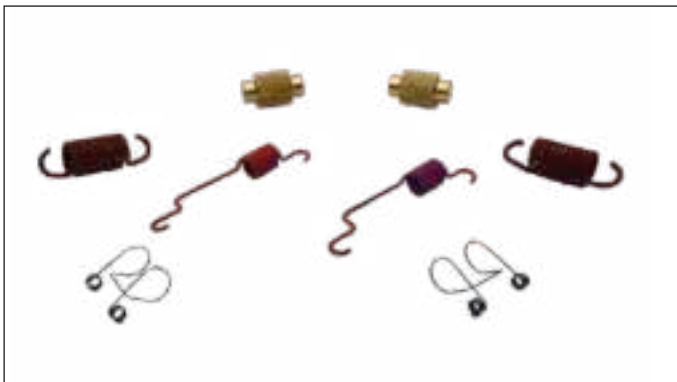

**Brake Shoe Repair Kit (502.610 )**

Code	502.610
OEM Number	R507094
Suitable for	ROR-MERITOR
Packing Weight	0.85 KG
Quantity in Pallet	0
Quantity in Box	1



**Brake Shoe Repair Kit (010.682 )**

Code	010.682
OEM Number	81502136006S
Suitable for	MAN MERCEDES
Packing Weight	1.52 KG
Quantity in Pallet	676
Quantity in Box	2

## BRAKE SHOE REPAIR KIT

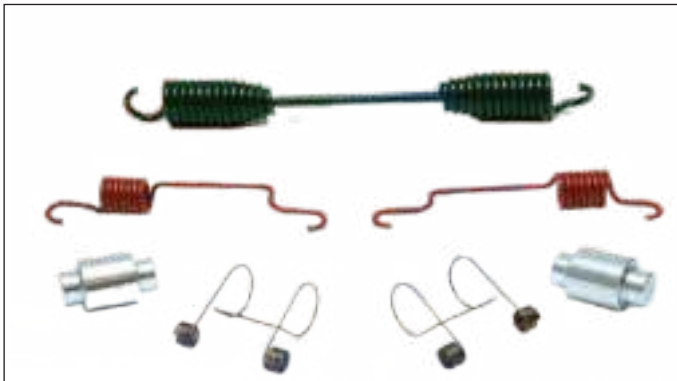

### Brake Shoe Repair Kit (503.523 )

Code	503.523
OEM Number	MKT4709ES2
Suitable for	ROR-MERITOR
Packing Weight	0.97 KG
Quantity in Pallet	0
Quantity in Box	1



### Brake Shoe Repair Kit (010.596 )

Code	010.596
OEM Number	3954200041
Suitable for	MERCEDES
Packing Weight	1.21 KG
Quantity in Pallet	0
Quantity in Box	1



### Brake Shoe Repair Kit (085.532 )

Code	085.532
OEM Number	15226262
Suitable for	ROR-MERITOR
Packing Weight	1.62 KG
Quantity in Pallet	0
Quantity in Box	6

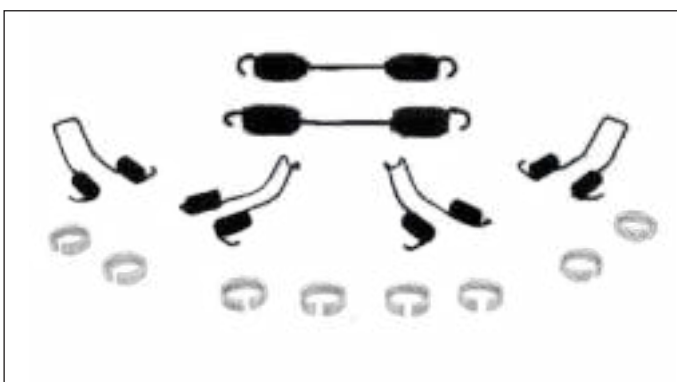

### Brake Shoe Repair Kit (070.658 )

Code	070.658
OEM Number	0980106790
Suitable for	BPW
Packing Weight	1.48 KG
Quantity in Pallet	0
Quantity in Box	1

## BRAKE SHOE REPAIR KIT



### Brake Shoe Repair Kit (060.656 )

Code	060.656
OEM Number	93161851
Suitable for	IVECO
Packing Weight	0.18 KG
Quantity in Pallet	0
Quantity in Box	2



### Brake Shoe Repair Kit (080.571 )

Code	080.571
OEM Number	5000737308S
Suitable for	RENAULT TRUCKS
Packing Weight	6.80 KG
Quantity in Pallet	0
Quantity in Box	10



### Brake Shoe Repair Kit (070.553 )

Code	070.553
OEM Number	0533184010
Suitable for	BPW
Packing Weight	0.71 KG
Quantity in Pallet	0
Quantity in Box	1



### Brake Shoe Repair Kit (080.548 )

Code	080.548
OEM Number	5010067400S3
Suitable for	RENAULT TRUCKS
Packing Weight	0.94 KG
Quantity in Pallet	0
Quantity in Box	1



## BRAKE SHOE REPAIR KIT



### Brake Shoe Repair Kit (040.539 )

Code	040.539
OEM Number	1362721S
Suitable for	SCANIA
Packing Weight	2.02 KG
Quantity in Pallet	0
Quantity in Box	2



### Brake Shoe Repair Kit (502.710 )

Code	502.710
OEM Number	MKT4515QHDB
Suitable for	ROR-MERITOR
Packing Weight	1.71 KG
Quantity in Pallet	0
Quantity in Box	1



### Brake Shoe Repair Kit (501.030 )

Code	501.030
OEM Number	KIT8824HD
Suitable for	NAVISTAR ROR-MERITOR
Packing Weight	1.61 KG
Quantity in Pallet	0
Quantity in Box	1



### Brake Shoe Repair Kit (070.546 )

Code	070.546
OEM Number	0908446360
Suitable for	BPW
Packing Weight	1.22 KG
Quantity in Pallet	338
Quantity in Box	1

## BRAKE SHOE REPAIR KIT



### Brake Shoe Repair Kit (502.615 )

Code	502.615
OEM Number	R507063
Suitable for	ROR-MERITOR
Packing Weight	1.50 KG
Quantity in Pallet	0
Quantity in Box	1



### Brake Shoe Repair Kit (010.599 )

Code	010.599
OEM Number	3074200339
Suitable for	MAN MERCEDES
Packing Weight	1.52 KG
Quantity in Pallet	392
Quantity in Box	2



### Brake Shoe Repair Kit (070.527 )

Code	070.527
OEM Number	0980102120S
Suitable for	BPW
Packing Weight	2.58 KG
Quantity in Pallet	0
Quantity in Box	6



### Brake Shoe Repair Kit (085.512 )

Code	085.512
OEM Number	AXL126
Suitable for	ROR-MERITOR
Packing Weight	1.98 KG
Quantity in Pallet	240
Quantity in Box	1

## BRAKE SHOE REPAIR KIT



### Brake Shoe Repair Kit (088.510 )

Code	088.510
OEM Number	08910061
Suitable for	SMB
Packing Weight	1.01 KG
Quantity in Pallet	0
Quantity in Box	1



### Brake Shoe Repair Kit (040.534 )

Code	040.534
OEM Number	183924S
Suitable for	SCANIA
Packing Weight	1.58 KG
Quantity in Pallet	0
Quantity in Box	2



### Brake Shoe Repair Kit (502.618 )

Code	502.618
OEM Number	R507088
Suitable for	ROR-MERITOR
Packing Weight	1.61 KG
Quantity in Pallet	0
Quantity in Box	1



### Brake Shoe Repair Kit (050.548 )

Code	050.548
OEM Number	0145450S
Suitable for	DAF
Packing Weight	3.40 KG
Quantity in Pallet	0
Quantity in Box	5

## BRAKE SHOE REPAIR KIT



### Brake Shoe Repair Kit (070.550 )

Code	070.550
OEM Number	0580152720
Suitable for	BPW
Packing Weight	0.86 KG
Quantity in Pallet	0
Quantity in Box	1



### Brake Shoe Repair Kit (502.620 )

Code	502.620
OEM Number	KIT9081
Suitable for	ROR-MERITOR
Packing Weight	2.15 KG
Quantity in Pallet	0
Quantity in Box	1



### Brake Shoe Repair Kit (075.535 )

Code	075.535
OEM Number	5000816353
Suitable for	RENAULT TRUCKS SAF
Packing Weight	2.94 KG
Quantity in Pallet	852
Quantity in Box	6



### Brake Shoe Repair Kit (500.680 )

Code	500.680
OEM Number	S23752
Suitable for	HENDRICKSON ROR-MERITOR
Packing Weight	1.67 KG
Quantity in Pallet	0
Quantity in Box	1

## BRAKE SHOE REPAIR KIT



### Brake Shoe Repair Kit (501.026 )

Code	501.026
OEM Number	R507008
Suitable for	LELAND ROR-MERITOR
Packing Weight	1.63 KG
Quantity in Pallet	0
Quantity in Box	1



### Brake Shoe Repair Kit (085.531 )

Code	085.531
OEM Number	15226632
Suitable for	ROR-MERITOR
Packing Weight	2.22 KG
Quantity in Pallet	864
Quantity in Box	6



### Brake Shoe Repair Kit (075.535/1 )

Code	075.535/1
OEM Number	3213002301S
Suitable for	SAF
Packing Weight	0.93 KG
Quantity in Pallet	0
Quantity in Box	1



### Brake Shoe Repair Kit (075.582 )

Code	075.582
OEM Number	3213000406
Suitable for	SAF
Packing Weight	4.56 KG
Quantity in Pallet	0
Quantity in Box	4

## BRAKE SHOE REPAIR KIT



### Brake Shoe Repair Kit (085.527A )

Code	085.527A
OEM Number	15205204S1
Suitable for	ROR-MERITOR
Packing Weight	0.26 KG
Quantity in Pallet	0
Quantity in Box	2



### Brake Shoe Repair Kit (500.680/1 )

Code	500.680/1
OEM Number	KIT8000MBHD
Suitable for	ROR-MERITOR
Packing Weight	1.60 KG
Quantity in Pallet	0
Quantity in Box	1



### Brake Shoe Repair Kit (075.565 )

Code	075.565
OEM Number	-
Suitable for	SAF
Packing Weight	2.03 KG
Quantity in Pallet	0
Quantity in Box	1

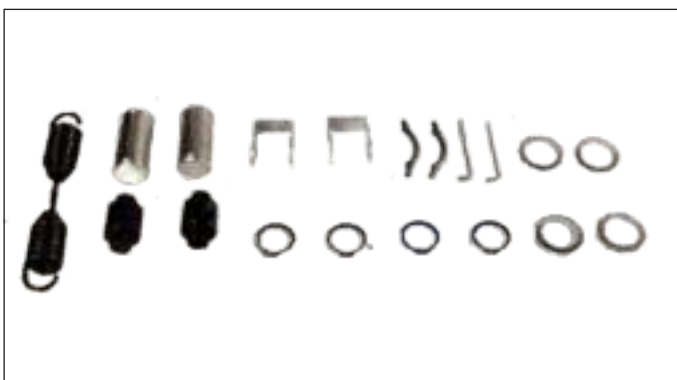

### Brake Shoe Repair Kit (082.507 )

Code	082.507
OEM Number	6504775W
Suitable for	TRAILOR
Packing Weight	1.82 KG
Quantity in Pallet	0
Quantity in Box	1

## BRAKE SHOE REPAIR KIT



### Brake Shoe Repair Kit (500.018/1 )

Code	500.018/1
OEM Number	KIT8000MB
Suitable for	ROR-MERITOR
Packing Weight	1.51 KG
Quantity in Pallet	0
Quantity in Box	1



### Brake Shoe Repair Kit (070.553 )

Code	070.553
OEM Number	0533184010
Suitable for	BPW
Packing Weight	0.71 KG
Quantity in Pallet	0
Quantity in Box	1



### Brake Shoe Repair Kit (070.523 )

Code	070.523
OEM Number	0980102090S
Suitable for	BPW
Packing Weight	4.50 KG
Quantity in Pallet	0
Quantity in Box	6



### Brake Shoe Repair Kit (085.532 )

Code	085.532
OEM Number	15226262
Suitable for	ROR-MERITOR
Packing Weight	1.62 KG
Quantity in Pallet	0
Quantity in Box	6

## BRAKE SHOE REPAIR KIT

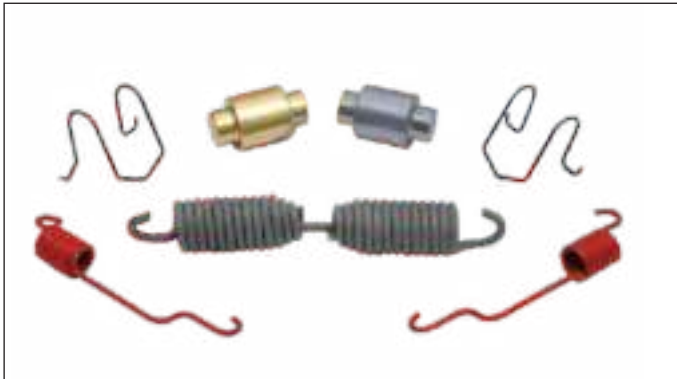

### Brake Shoe Repair Kit (501.033 )

Code	501.033
OEM Number	R507064
Suitable for	ROR-MERITOR
Packing Weight	0.94 KG
Quantity in Pallet	0
Quantity in Box	1



### Brake Shoe Repair Kit (010.598 )

Code	010.598
OEM Number	3354200039
Suitable for	MERCEDES
Packing Weight	1.58 KG
Quantity in Pallet	0
Quantity in Box	2



### Brake Shoe Repair Kit (501.029 )

Code	501.029
OEM Number	KIT9179
Suitable for	LELAND ROR-MERITOR
Packing Weight	2.23 KG
Quantity in Pallet	0
Quantity in Box	1



### Brake Shoe Repair Kit (080.546 )

Code	080.546
OEM Number	5010067400S1
Suitable for	RENAULT TRUCKS
Packing Weight	0.94 KG
Quantity in Pallet	0
Quantity in Box	1



## BRAKE SHOE REPAIR KIT



### Brake Shoe Repair Kit (080.549 )

Code	080.549
OEM Number	5000816356S
Suitable for	RENAULT TRUCKS SAF SCHMITZ CARGOBULL
Packing Weight	0.66 KG
Quantity in Pallet	0
Quantity in Box	2



### Brake Shoe Repair Kit (090.513 )

Code	090.513
OEM Number	ARJA0199707
Suitable for	FRUEHAUF
Packing Weight	1.83 KG
Quantity in Pallet	0
Quantity in Box	1



### Brake Shoe Repair Kit (502.622 )

Code	502.622
OEM Number	K283
Suitable for	LELAND ROR-MERITOR
Packing Weight	1.13 KG
Quantity in Pallet	0
Quantity in Box	1



### Brake Shoe Repair Kit (080.567 )

Code	080.567
OEM Number	0000189976S1
Suitable for	RENAULT TRUCKS
Packing Weight	2.87 KG
Quantity in Pallet	0
Quantity in Box	1

## BRAKE SHOE REPAIR KIT



### Brake Shoe Repair Kit (085.511 )

Code	085.511
OEM Number	AXL125
Suitable for	ROR-MERITOR
Packing Weight	1.90 KG
Quantity in Pallet	144
Quantity in Box	1



### Brake Shoe Repair Kit (030.530 )

Code	030.530
OEM Number	348979S
Suitable for	VOLVO
Packing Weight	1.55 KG
Quantity in Pallet	0
Quantity in Box	1



### Brake Shoe Repair Kit (010.682 )

Code	010.682
OEM Number	81502136006S
Suitable for	MAN MERCEDES
Packing Weight	1.52 KG
Quantity in Pallet	676
Quantity in Box	2

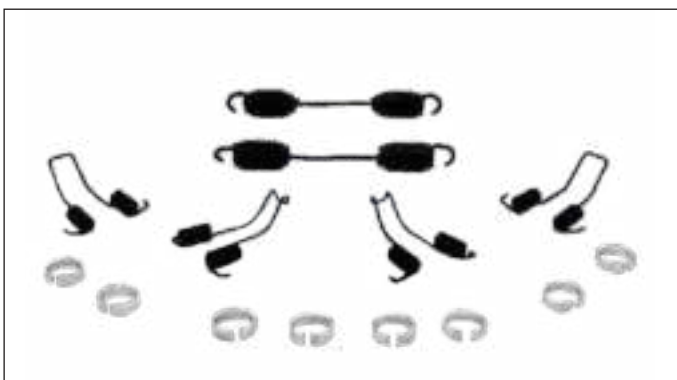

### Brake Shoe Repair Kit (070.658 )

Code	070.658
OEM Number	0980106790
Suitable for	BPW
Packing Weight	1.48 KG
Quantity in Pallet	0
Quantity in Box	1

## BRAKE SHOE REPAIR KIT



### Brake Shoe Repair Kit (501.028 )

Code	501.028
OEM Number	R507072
Suitable for	LELAND ROR-MERITOR
Packing Weight	1.63 KG
Quantity in Pallet	0
Quantity in Box	1



### Brake Shoe Repair Kit (050.545 )

Code	050.545
OEM Number	0593595S
Suitable for	DAF
Packing Weight	1.48 KG
Quantity in Pallet	376
Quantity in Box	2



### Brake Shoe Repair Kit (082.506 )

Code	082.506
OEM Number	6502102W
Suitable for	TRAILOR
Packing Weight	1.94 KG
Quantity in Pallet	0
Quantity in Box	1



### Brake Shoe Repair Kit (070.525 )

Code	070.525
OEM Number	0980102100S
Suitable for	BPW
Packing Weight	4.02 KG
Quantity in Pallet	798
Quantity in Box	6

## BRAKE SHOE REPAIR KIT



### Brake Shoe Repair Kit (084.505 )

Code	084.505
OEM Number	-
Suitable for	SETRA
Packing Weight	1.45 KG
Quantity in Pallet	0
Quantity in Box	1



### Brake Shoe Repair Kit (085.520 )

Code	085.520
OEM Number	AXLLM4
Suitable for	ROR-MERITOR
Packing Weight	1.97 KG
Quantity in Pallet	0
Quantity in Box	1



### Brake Shoe Repair Kit (087.505 )

Code	087.505
OEM Number	08804086S
Suitable for	GIGANT
Packing Weight	2.04 KG
Quantity in Pallet	0
Quantity in Box	6

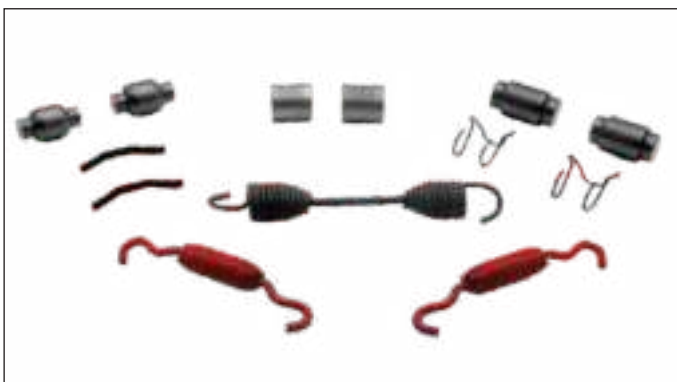

### Brake Shoe Repair Kit (501.030 )

Code	501.030
OEM Number	KIT8824HD
Suitable for	NAVISTAR ROR-MERITOR
Packing Weight	1.61 KG
Quantity in Pallet	0
Quantity in Box	1

## BRAKE SHOE REPAIR KIT



### Brake Shoe Repair Kit (085.528 )

Code	085.528
OEM Number	AXL7
Suitable for	ROR-MERITOR
Packing Weight	0.92 KG
Quantity in Pallet	0
Quantity in Box	1



### Brake Shoe Repair Kit (501.020 )

Code	501.020
OEM Number	R508030
Suitable for	ROR-MERITOR
Packing Weight	0.60 KG
Quantity in Pallet	0
Quantity in Box	1



### Brake Shoe Repair Kit (010.594 )

Code	010.594
OEM Number	3184200182
Suitable for	MERCEDES
Packing Weight	0.93 KG
Quantity in Pallet	0
Quantity in Box	1



### Brake Shoe Repair Kit (080.548 )

Code	080.548
OEM Number	5010067400S3
Suitable for	RENAULT TRUCKS
Packing Weight	0.94 KG
Quantity in Pallet	0
Quantity in Box	1

## BRAKE SHOE REPAIR KIT



### Brake Shoe Repair Kit (040.539 )

Code	040.539
OEM Number	1362721S
Suitable for	SCANIA
Packing Weight	2.02 KG
Quantity in Pallet	0
Quantity in Box	2



### Brake Shoe Repair Kit (085.513 )

Code	085.513
OEM Number	AXL106
Suitable for	ROR-MERITOR
Packing Weight	2.06 KG
Quantity in Pallet	0
Quantity in Box	1



### Brake Shoe Repair Kit (070.642 )

Code	070.642
OEM Number	-
Suitable for	BPW
Packing Weight	2.27 KG
Quantity in Pallet	0
Quantity in Box	1



### Brake Shoe Repair Kit (070.573 )

Code	070.573
OEM Number	0980102450
Suitable for	BPW
Packing Weight	2.28 KG
Quantity in Pallet	0
Quantity in Box	1

## BRAKE SHOE REPAIR KIT



### Brake Shoe Repair Kit (080.564 )

Code	080.564
OEM Number	5010097089S
Suitable for	RENAULT TRUCKS
Packing Weight	1.73 KG
Quantity in Pallet	0
Quantity in Box	1



### Brake Shoe Repair Kit (502.619 )

Code	502.619
OEM Number	R509408
Suitable for	ROR-MERITOR
Packing Weight	2.20 KG
Quantity in Pallet	0
Quantity in Box	1



### Brake Shoe Repair Kit (080.562 )

Code	080.562
OEM Number	5000816349S
Suitable for	RENAULT TRUCKS
Packing Weight	1.08 KG
Quantity in Pallet	0
Quantity in Box	1



### Brake Shoe Repair Kit (087.504 )

Code	087.504
OEM Number	08804062S
Suitable for	GIGANT
Packing Weight	2.10 KG
Quantity in Pallet	0
Quantity in Box	6

## BRAKE SHOE REPAIR KIT



### Brake Shoe Repair Kit (050.547 )

Code	050.547
OEM Number	0364577S
Suitable for	DAF
Packing Weight	0.80 KG
Quantity in Pallet	0
Quantity in Box	2



### Brake Shoe Repair Kit (070.765 )

Code	070.765
OEM Number	-
Suitable for	BPW
Packing Weight	2.38 KG
Quantity in Pallet	0
Quantity in Box	1



### Brake Shoe Repair Kit (070.555 )

Code	070.555
OEM Number	0980102010
Suitable for	BPW
Packing Weight	1.92 KG
Quantity in Pallet	0
Quantity in Box	1



### Brake Shoe Repair Kit (090.506 )

Code	090.506
OEM Number	M009279
Suitable for	FRUEHAUF SMB
Packing Weight	1.92 KG
Quantity in Pallet	144
Quantity in Box	1



## BRAKE SHOE REPAIR KIT



### Brake Shoe Repair Kit (085.536 )

Code	085.536
OEM Number	21221224S
Suitable for	ROR-MERITOR
Packing Weight	2.76 KG
Quantity in Pallet	0
Quantity in Box	6



### Brake Shoe Repair Kit (050.745 )

Code	050.745
OEM Number	0667965S2
Suitable for	DAF
Packing Weight	0.82 KG
Quantity in Pallet	0
Quantity in Box	2



### Brake Shoe Repair Kit (010.600B )

Code	010.600B
OEM Number	3074204002S1
Suitable for	MAN MERCEDES
Packing Weight	0.64 KG
Quantity in Pallet	0
Quantity in Box	1



### Brake Shoe Repair Kit (070.569 )

Code	070.569
OEM Number	0908446390
Suitable for	BPW
Packing Weight	1.24 KG
Quantity in Pallet	0
Quantity in Box	1

## BRAKE SHOE REPAIR KIT



### Brake Shoe Repair Kit (502.784 )

Code	502.784
OEM Number	KIT8014
Suitable for	FRUEHAUF ROR-MERITOR
Packing Weight	0.89 KG
Quantity in Pallet	0
Quantity in Box	1



### Brake Shoe Repair Kit (085.542 )

Code	085.542
OEM Number	-
Suitable for	ROR-MERITOR
Packing Weight	1.98 KG
Quantity in Pallet	0
Quantity in Box	1



### Brake Shoe Repair Kit (090.512 )

Code	090.512
OEM Number	-
Suitable for	FRUEHAUF
Packing Weight	3.63 KG
Quantity in Pallet	0
Quantity in Box	1



### Brake Shoe Repair Kit (084.504 )

Code	084.504
OEM Number	8285049053
Suitable for	NEOPLAN SETRA
Packing Weight	1.10 KG
Quantity in Pallet	0
Quantity in Box	2

## BRAKE SHOE REPAIR KIT

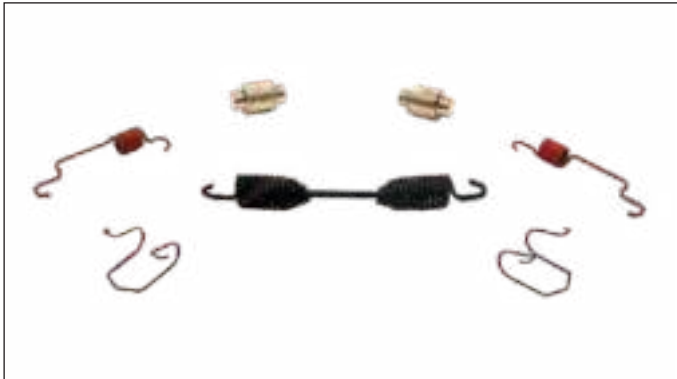

### Brake Shoe Repair Kit (502.608 )

Code	502.608
OEM Number	R615026
Suitable for	ROR-MERITOR
Packing Weight	0.91 KG
Quantity in Pallet	0
Quantity in Box	1



### Brake Shoe Repair Kit (011.705 )

Code	011.705
OEM Number	0004200139
Suitable for	MERCEDES
Packing Weight	1.43 KG
Quantity in Pallet	0
Quantity in Box	1



### Brake Shoe Repair Kit (070.572 )

Code	070.572
OEM Number	0980102470
Suitable for	BPW
Packing Weight	1.85 KG
Quantity in Pallet	0
Quantity in Box	1



### Brake Shoe Repair Kit (080.566 )

Code	080.566
OEM Number	0000189976S
Suitable for	RENAULT TRUCKS
Packing Weight	6.40 KG
Quantity in Pallet	0
Quantity in Box	10

## BRAKE SHOE REPAIR KIT

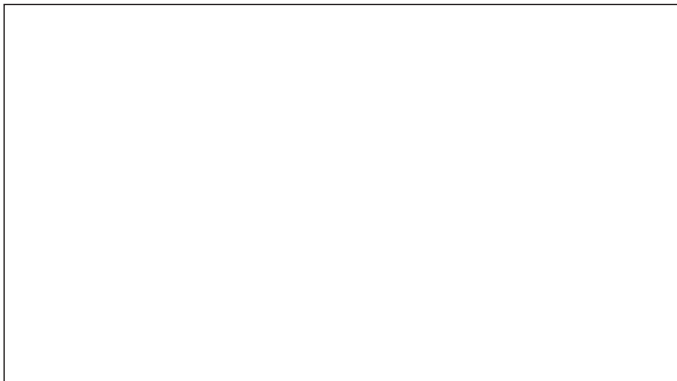

### Brake Shoe Repair Kit (090.529 )

Code	090.529
OEM Number	-
Suitable for	FRUEHAUF
Packing Weight	1.80 KG
Quantity in Pallet	0
Quantity in Box	2



### Brake Shoe Repair Kit (075.637 )

Code	075.637
OEM Number	3054012000S
Suitable for	SAF
Packing Weight	1.78 KG
Quantity in Pallet	0
Quantity in Box	1



### Brake Shoe Repair Kit (082.512 )

Code	082.512
OEM Number	6502101T
Suitable for	TRAILOR
Packing Weight	1.38 KG
Quantity in Pallet	0
Quantity in Box	6



### Brake Shoe Repair Kit (070.588 )

Code	070.588
OEM Number	0980102460
Suitable for	BPW
Packing Weight	2.77 KG
Quantity in Pallet	0
Quantity in Box	1

## BRAKE SHOE REPAIR KIT



### Brake Shoe Repair Kit (070.554 )

Code	070.554
OEM Number	0908446110
Suitable for	BPW
Packing Weight	1.17 KG
Quantity in Pallet	0
Quantity in Box	1



### Brake Shoe Repair Kit (085.530 )

Code	085.530
OEM Number	-
Suitable for	ROR-MERITOR
Packing Weight	1.34 KG
Quantity in Pallet	0
Quantity in Box	1



### Brake Shoe Repair Kit (502.607 )

Code	502.607
OEM Number	R507002
Suitable for	LELAND ROR-MERITOR
Packing Weight	1.09 KG
Quantity in Pallet	0
Quantity in Box	1



### Brake Shoe Repair Kit (070.764 )

Code	070.764
OEM Number	-
Suitable for	BPW
Packing Weight	1.75 KG
Quantity in Pallet	0
Quantity in Box	1

## BRAKE SHOE REPAIR KIT



### Brake Shoe Repair Kit (030.531 )

Code	030.531
OEM Number	348979S1
Suitable for	VOLVO
Packing Weight	1.84 KG
Quantity in Pallet	0
Quantity in Box	1



### Brake Shoe Repair Kit (030.532 )

Code	030.532
OEM Number	341717S
Suitable for	VOLVO
Packing Weight	1.85 KG
Quantity in Pallet	0
Quantity in Box	1



### Brake Shoe Repair Kit (040.901 )

Code	040.901
OEM Number	154262S
Suitable for	SCANIA
Packing Weight	1.70 KG
Quantity in Pallet	0
Quantity in Box	1



### Brake Shoe Repair Kit (041.530 )

Code	041.530
OEM Number	141163S1
Suitable for	SCANIA
Packing Weight	0.16 KG
Quantity in Pallet	0
Quantity in Box	2

## BRAKE SHOE REPAIR KIT



### Brake Shoe Repair Kit (050.546 )

Code	050.546
OEM Number	0593595S1
Suitable for	DAF
Packing Weight	0.98 KG
Quantity in Pallet	0
Quantity in Box	2



### Brake Shoe Repair Kit (075.559 )

Code	075.559
OEM Number	3434360800
Suitable for	SAF
Packing Weight	2.32 KG
Quantity in Pallet	0
Quantity in Box	1

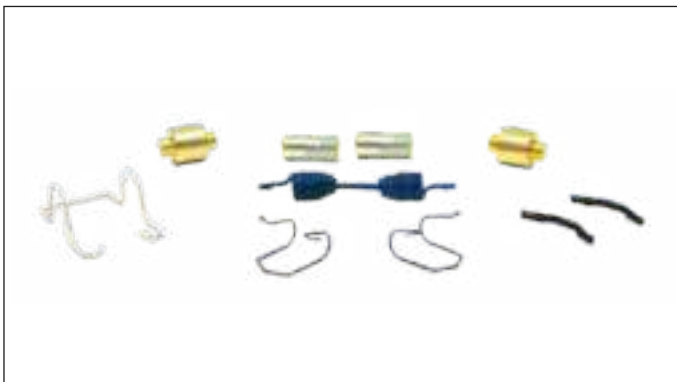

### Brake Shoe Repair Kit (502.612 )

Code	502.612
OEM Number	R507090
Suitable for	ROR-MERITOR
Packing Weight	1.41 KG
Quantity in Pallet	0
Quantity in Box	1



### Brake Shoe Repair Kit (085.521 )

Code	085.521
OEM Number	AXLLM1
Suitable for	ROR-MERITOR
Packing Weight	2.75 KG
Quantity in Pallet	0
Quantity in Box	1

## BRAKE SHOE REPAIR KIT



### Brake Shoe Repair Kit (080.565 )

Code	080.565
OEM Number	5010098945S
Suitable for	RENAULT TRUCKS
Packing Weight	0.98 KG
Quantity in Pallet	0
Quantity in Box	1



### Brake Shoe Repair Kit (010.597 )

Code	010.597
OEM Number	3074204102
Suitable for	MERCEDES
Packing Weight	1.37 KG
Quantity in Pallet	188
Quantity in Box	1



### Brake Shoe Repair Kit (502.609 )

Code	502.609
OEM Number	R507062
Suitable for	ROR-MERITOR
Packing Weight	1.68 KG
Quantity in Pallet	0
Quantity in Box	1





We cater to our clients worldwide and have been exporting to U.S.A., U.K., U.A.E., Saudi Arabia and Iran to name a few.

[www.sksgiving.com](http://www.sksgiving.com)



**SK Spring Co.**  
Behrampur Industrial Area, Begampur Khatola Road  
Khandsa, Gurgaon-122001, Haryana, INDIA

Tel: +91.124.4379809  
Email: [info@sksgiving.com](mailto:info@sksgiving.com)

**Corporate office**  
510, 5th Floor, Spaze Platinum Towers  
Sohna Road Gurgaon 122001  
Haryana, India

### AN IATF/ISO CERTIFIED COMPANY



**IATF 16949:2016**



**ISO 9001:2015**

